

























TU
BI
SEBASTIANO
TOSI



minottiitalia

DA TI TE CNI CI TE CH NIC AL DA TA

| | | | |
|---|--|--|--|
|  | LACCATURA GOFFRATA NEI COLORI A CAMPIONARIO |  | TEAK OPACO / MDF NERO |
|  | FOGLIA ORO |  | CEMENTO BIANCO |
|  | FOGLIA ARGENTO |  | CEMENTO GRIGIO |
|  | OTTONE LUCIDO |  | LED LUCE BIANCA CALDA / FREDDA (3000/6000 K) |
|  | NICHEL LUCIDO |  | LED LUCE CALDA 4 CANALI (RGB WW) |
|  | OTTONE SATINATO |  | MODULO DESTRO / SINISTRO |
|  | NICHEL SATINATO |  | FISSAGGIO A PARETE |
|  | INOX |  | ASSEMBLARE |
|  | METALLO BIANCO GOFFRATO |  | RIPIANO SPOSTABILE |
|  | METALLO ANTRACITE GOFFRATO |  | RIPIANO FISSO |
|  | METALLO BIANCO OPACO |  | VOLUME |
|  | NICHEL NERO |  | NUMERO DI COLLI |
|  | SPECCHIO STANDARD |  | PESO |
|  | SPECCHIO BRONZATO | | |
|  | SPECCHIO FUME' | | |
|  | APERTURA VASISTAS / RIBALTA | | |
|  | APERTURA DESTRA / SINISTRA | | |
|  | RIPIANO IN CRISTALLO EXTRA CHIARO | | |
|  | ESSENZA LARICE SPAZZOLATO / FINITURA LACCATO GOFFRATO NEI COLORI A CAMPIONARIO | | |

Tavolo in tubolare di ferro, telaio disponibile in colore nero finitura opaca, puntali in ottone lucido o nichel lucido, piani in cristallo extra - chiaro o fumè grigio europa.

Table in iron tubular, structure available in black matt finish, toppers in bright brass or bright nickel, tops in extra-clear crystal glass or grey fume' europa.



1,3



2



120

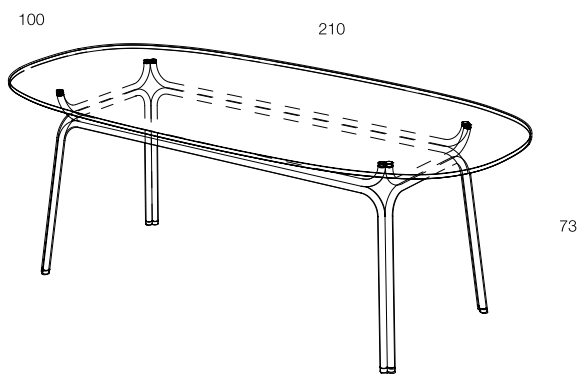

A.
D.
&
GRA
PH
ICS

STUDIO14

minottiitalia

ADION S.R.L.
VIALE REPUBBLICA, 140
22060 – CABIATE – COMO
+39 031 769 251
INFO@MINOTTIITALIA.IT
WWW.MINOTTIITALIA.IT