

The sizes are expressed in millimeters.

DESIGN OMAR CARRAGLIA - DAVIDE GROPPI - 2015
LAMPADA DA PARETE - METALLO
WALL LAMP - METAL

DOT P

 ENDLESS SYSTEM VERSION AVAILABLE

CE IP20

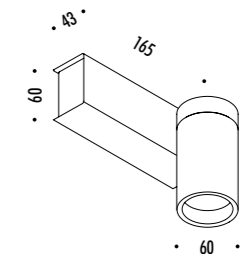
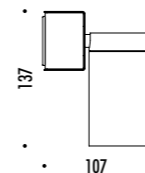
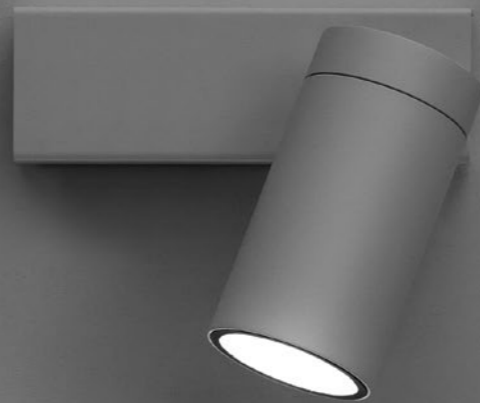

1A2340300.27.04	BIANCO OPACO / MATT WHITE - 2700K - PUSH	100-240 V - 50/60 Hz - 13 W LED
1A2340300.30.04	BIANCO OPACO / MATT WHITE - 3000K - PUSH	WITH LENS 1A3090000.00.00: 2700K - 983 lm - CRI 97 / 3000K - 1038 lm - CRI 97
1A2340400.27.04	NERO OPACO / MATT BLACK - 2700K - PUSH	WITH LENS 1A3100000.00.00: 2700K - 943 lm - CRI 97 / 3000K - 996 lm - CRI 97
1A2340400.30.04	NERO OPACO / MATT BLACK - 3000K - PUSH	WITH LENS 1A3110000.00.00: 2700K - 955 lm - CRI 97 / 3000K - 1005 lm - CRI 97
		WITH LENS 1A3120000.00.00: 2700K - 965 lm - CRI 97 / 3000K - 1016 lm - CRI 97
		ORIENTABILE - DIMMERABILE
		ACCESSORI OPZIONALI LAMPADINA NON INCLUSI
		ADJUSTABLE - DIMMABLE
		OPTIONAL BULB ACCESSORIES NOT INCLUDED

ACCESSORI OBBLIGATORI / COMPULSORY ACCESSORIES

1A3090000.00.00	LENS - NARROW BEAM	DOT LENS
1A3100000.00.00	LENS - MEDIUM BEAM	
1A3110000.00.00	LENS - WIDE BEAM	
1A3120000.00.00	LENS - ULTRA WIDE BEAM	



The sizes are expressed in millimeters.

DESIGN OMAR CARRAGLIA - DAVIDE GROPPI - 2015
LAMPADA DA PARETE - METALLO
WALL LAMP - METAL

DOT P 51



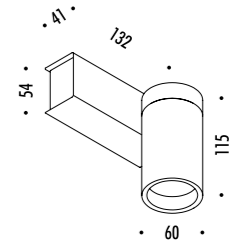
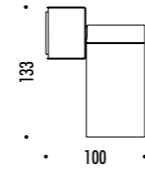



CE IP20



1A2490300.00.00	BIANCO OPACO / MATT WHITE - ON/OFF	100-240 V - 50/60 Hz - MAX 10 W LED - GU10 ORIENTABILE LAMPADINA NON INCLUSA ACCESSORI OPZIONALI LAMPADINA NON INCLUSI ADJUSTABLE BULB NOT INCLUDED OPTIONAL BULB ACCESSORIES NOT INCLUDED
1A2490400.00.00	NERO OPACO / MATT BLACK - ON/OFF	

CODE	SOCKET	TENSION	WATTAGE	BEAM ANGLE (°)	TEMPERATURE (K)	SOURCE LUMENS	BULB EFFICIENCY	CRI (Ra)	DIMMABLE	PRODUCT REFERENCE
------	--------	---------	---------	----------------	-----------------	---------------	-----------------	----------	----------	-------------------

LAMPADINE LED / LED BULBS

	50330500	GU10	220-240 V	5,5 W	25°	3000K	375 lm	G	97	X	DOT P 51 DOT PL 51 DOT R 51 DOT SISTEMA 51 MINI 51 MINI BIT 51 MINI PL MOON 60 DE TRICK TRACK
	50330740	GU10	220-240 V	4,9 W	120°	3000K	550 lm	E	80	-	Q
	50330450	GU4	12 V	20 W	24°	2700K	200 lm	G	80	-	OVO OVONELPIATTO
	50330530	GU5,3	12 V	6,7 W	36°	3000K	440 lm	G	97	X	BUCO R
	50041410	E14	220-240 V	4,5 W	-	2700K	470 lm	F	>80	X	PALPEBRA
	52080010	E27	220-240 V	7 W	360°	2700K	806 lm	E	80	X	ABA 45 ABA 120 EDI SON
	50330650	E27	220-240 V	13 W	200°	2700K	1521 lm	E	80	-	LENTA MOON 60 MOON 60 DE MOON 80 MOON 200 MOON T SHOJI SHOJI OUTDOOR
	50041470	E27	220-240 V	21 W	200°	2700K	2452 lm	E	>80	X	MOON 120
	50330730	E27	220-240 V	9,5 W	25°	3000K	760 lm	F	80	X	CHILLOUT NEURO

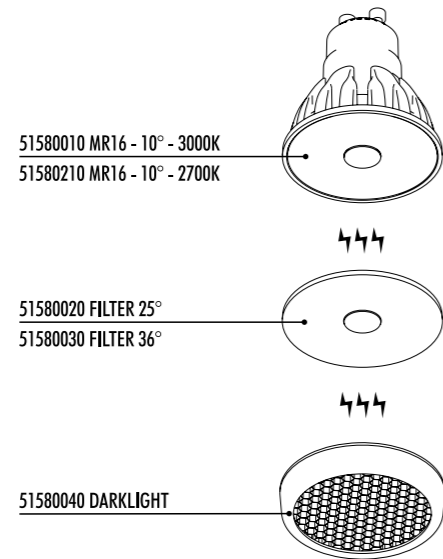

CODE	SOCKET	TENSION	WATTAGE	BEAM ANGLE (°)	TEMPERATURE (K)	SOURCE LUMENS	BULB EFFICIENCY	CRi (Ra)	DIMMABLE	PRODUCT REFERENCE
------	--------	---------	---------	----------------	-----------------	---------------	-----------------	----------	----------	-------------------

LAMPADINE LED SORAA MR16 - DIMMERABILE IGBT / SORAA LED BULBS MR16 - IGBT DIMMABLE

🔔	51580010	GU10	230 V	7,5 W	10°	3000K	410 lm	G	95	X	DOT P 51 DOT PL 51 DOT R 51 DOT SISTEMA 51
	51580210	GU10	230 V	7,5 W	10°	2700K	390 lm	G	95	X	MINI 51 MINI BIT 51 MINI PL TRICK TRACK

ACCESSORI "POINT SOURCE OPTICS" PER GENERARE FASCI UNIFORMI E DI ALTA INTENSITA' / "POINT SOURCE OPTICS" ACCESSORIES FOR UNIFORM AND HIGH INTENSITY BEAMS

51580020	FILTER - MR16			25°							DOT P 51 DOT PL 51 DOT R 51 DOT SISTEMA 51
51580030	FILTER - MR16			36°							MINI 51 MINI BIT 51 MINI PL TRICK TRACK
51580040	DARKLIGHT - MR16			-							MINI PL TRICK TRACK