



BOX 40 N LED Wandleuchte 3000 KELVIN





Chrom 0330700 / Gold 0330720 / Gold matt 0330782 / Roségold 0330716 / Nickel satiniert 0330734 /
Weiß matt 0330750 / Schwarz matt 0330760

BOX 40 N LED Wandleuchte 2700 KELVIN

Chrom 0333100 / Gold 0333120 / Gold matt 0333182 / Roségold 0333116 / Nickel satiniert 0333134 /
Weiß matt 0333150 / Schwarz matt 0333160

Beschreibung

Leuchtentyp	LED Wandleuchte	
Maße	5 x 40 x 10 cm [H . B . T]	
Montage	waagrecht	
Grundmaterial	Messing / Acrylglas satiniert	
Oberfläche	galvanisch [Chrom, Gold, Gold matt, Roségold, Nickel satiniert] lackiert [Weiß matt, Schwarz matt]	
Nettogewicht	1,9 kg	
Lichtrichtung	nach oben und unten	
Dimmbar	ja / dimmbar mit externem Phasenabschrittdimmer	
Betrieb	Direktanschluß / 230V	
Lebensdauer LED	50000 h	
CRI	> 80	
Farbtemperatur	3000 Kelvin	2700 Kelvin
Leuchtmittel	LED 21W – nicht austauschbar	LED 16W – nicht austauschbar
EEK	A++, A+, A – 23 kwh/1000h	A++, A+, A – 18 kwh/1000h
Lichtstrom	3100 lm	2440 lm

IP44    

Technische Zeichnung

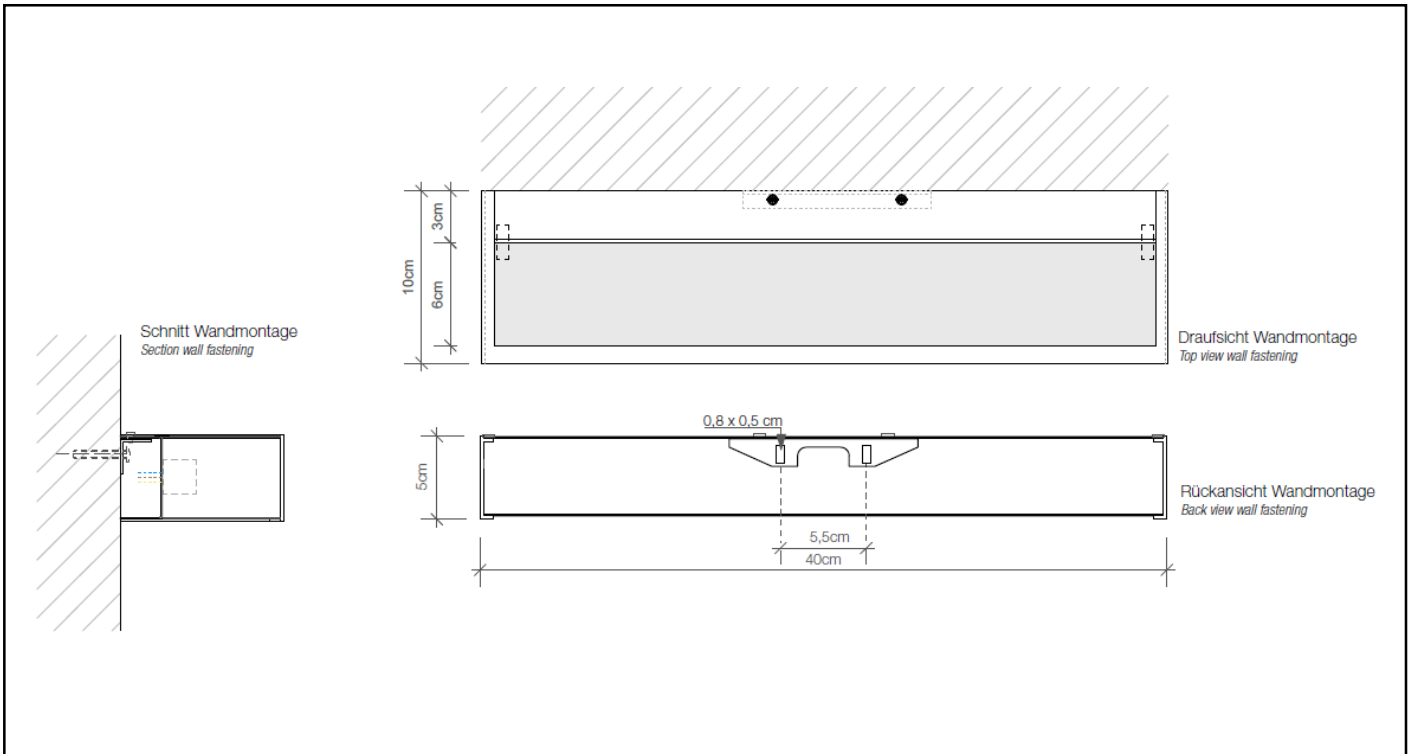



DECOR WALTHER

BOX 40 N LED
Wandleuchte
Wall light

BOX 1-40
N LED
Spiegelleuchte
Clip on light for
mirror

M 1 : 3

Chrom / Nickel
satiert / Gold /
Gold matt /
Roségold / Weiss
matt / Schwarz
matt

Chrome / Nickel satin
/ Gold / Gold matt /
Rose gold / White matt
/ Black matt

5 . 40 . 10 cm

Alle Angaben ohne Gewähr.
Maß und Modelländerungen
vorbehalten.
All information without engagement.
Measurement and changes
conditionally.

15.02.2019 TKH

www.decor-walther.de

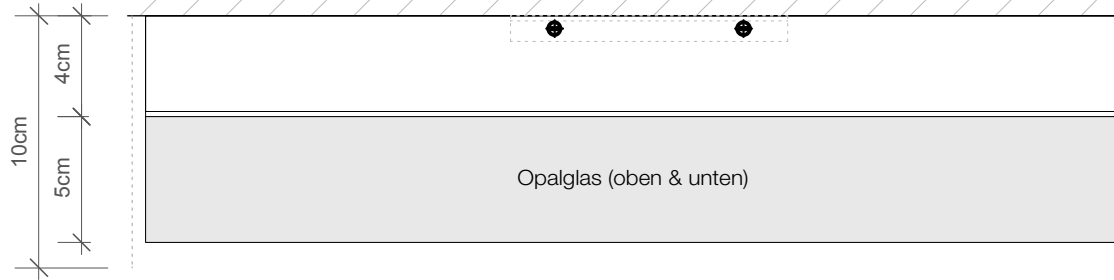

Draufsicht Wandmontage
Top view wall fastening

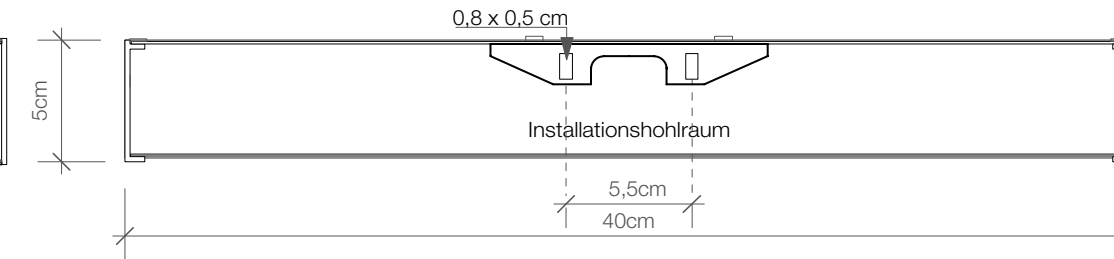

Rückansicht Wandmontage
Back view wall fastening

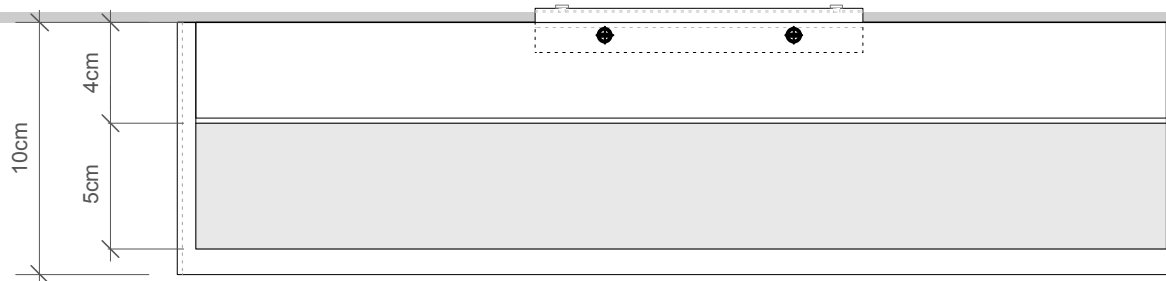

Draufsicht Spiegelmontage
Top view mirror fastening

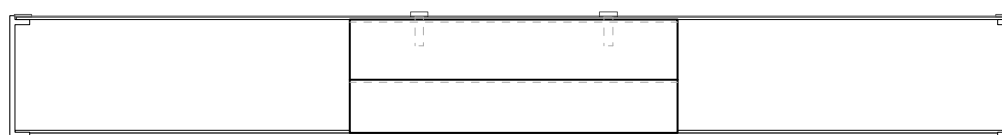
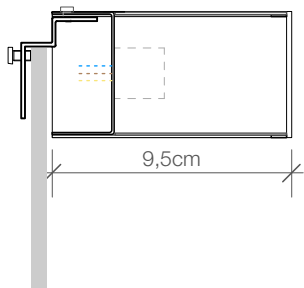

Rückansicht Spiegelmontage
Back view mirror fastening



BOX 40 N LED

Wand- und Spiegelleuchten
LED Lights

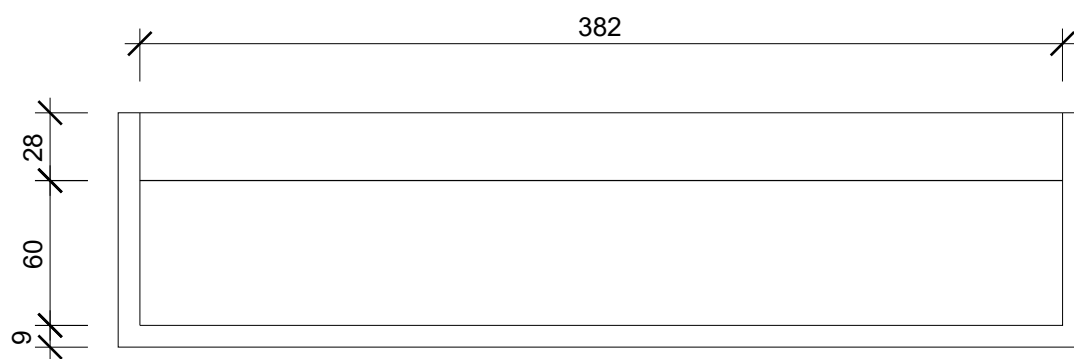
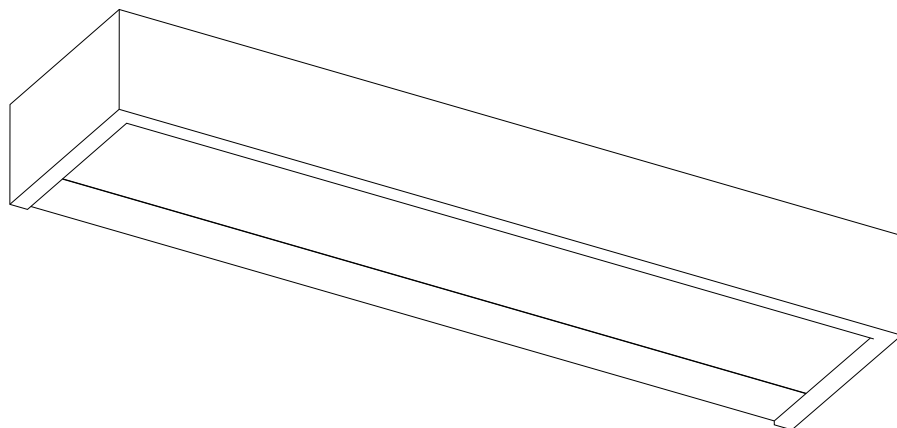

Untersicht
Bottom view

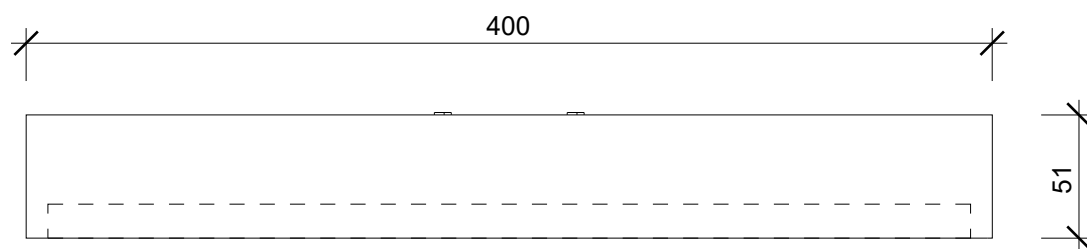

Frontansicht
front view

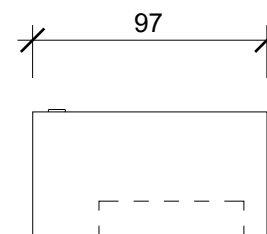

Seitenansicht
side view

Alle Angaben sind ohne Gewähr.
Maß und Modelländerungen
vorbehalten.
All information without
engagement. Measurement
and changes conditionally.

MONTAGEANLEITUNG
 MOUNTING INSTRUCTION
 INSTRUCTION DE MONTAGE
 ISTRUZIONI DI MONTAGGIO



BOX LED

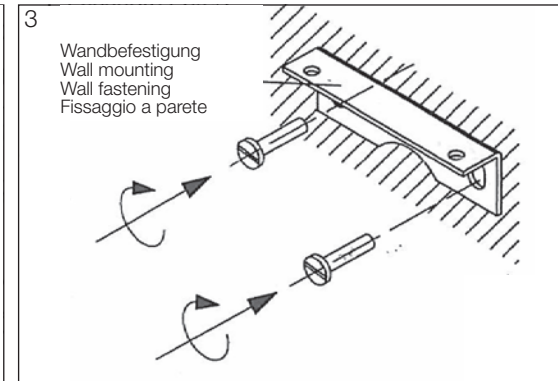
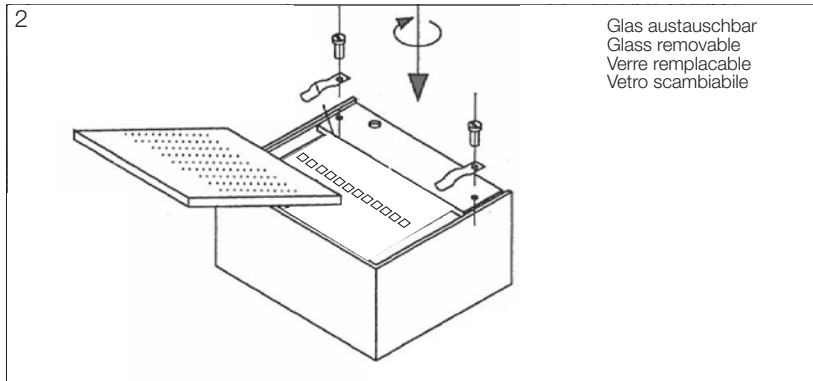
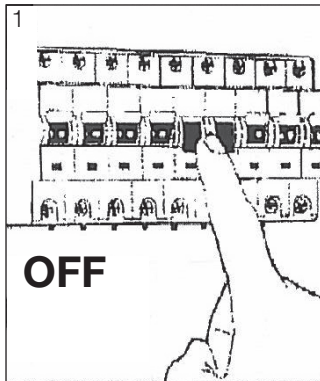

LED Leuchte mit fest verbauten LED's. Austausch der Lampen nur durch Decor Walther.

LED-lamp with fixed LED's. Replacement of lamp only through Decor Walther.

LEDs fixes dans la lampe. Remplacement seulement par Decor Walther.

Lampada LED con LED fisso. Lo scambio delle lampadine LED dovrà essere eseguito solo da Decor Walther.

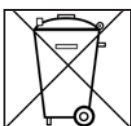
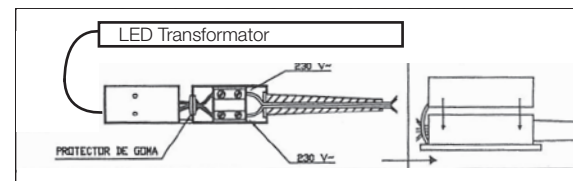
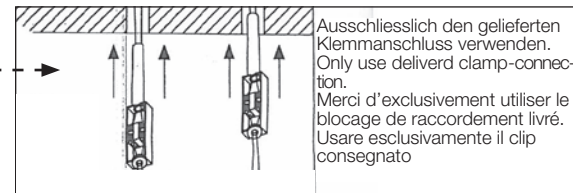
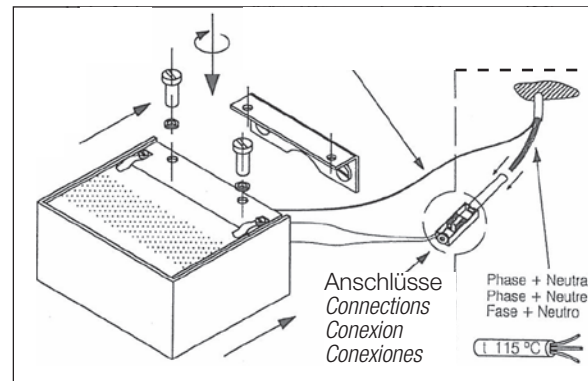

Nicht im Hausmüll entsorgen
 Do not recycle in household garbage
 Ne pas jeter l'article avec déchets ménagers
 Si prega da non smaltire la lampade in rifiuti domestici

ALLGEMEINE SICHERHEITSHINWEISE: Elektroinstallationen dürfen nur vom Fachmann durchgeführt werden. ACHTUNG: Vor dem Montagebeginn ist sicherzustellen, dass Ihre Netzzuleitung spannungsfrei ist! *GENEREL*
 SAFETY INSTRUCTIONS: Electric installations should be organized solely by an expert. ATTENTION: Before beginning of the mounting process, ensure yourself that the electric feeder is turned off!