



Standard



Optional



IS 15885 (Part 2/Sec13)  
R-41027766



■ Features

- Constant Current mode output with multiple levels selectable by dip switch
- Plastic housing with class II design
- Built-in active PFC function
- Standby power consumption <1W
- Functions: 3 in 1 dimming (dim-to-off); Auxiliary DC output; synchronization up to 10 units
- Optional: Wireless LED driver with integrated EnOcean module
- 3 years warranty

■ Applications

- LED indoor lighting
- LED office lighting
- LED architectural lighting
- LED panel lighting

■ Description

LCM-40 series is a 40W LED AC/DC constant current mode output LED driver featuring the multiple levels selectable by dip switch. LCM-40 operates from 180~295VAC and offers different current levels ranging between 350mA and 1050mA. Thanks to the efficiency up to 92%, with the fanless design, the entire series is able to operate for -30°C~+90°C case temperature under free air convection. LCM-40 is equipped with various functions, such as the dimming function and synchronization, so as to provide the optimal design flexibility for LED lighting system.

■ Model Encoding

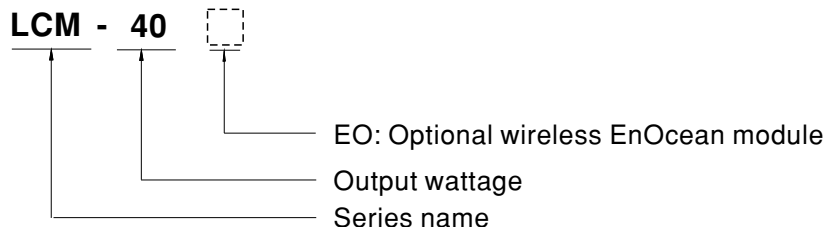

Type	Function	Note
Blank	3 in 1 dimming (dim-to-off)	In Stock
EO	Wireless driver with integrated EnOcean module	By request



**SPECIFICATION**

<b>MODEL</b>		<b>LCM-40</b>					
<b>OUTPUT</b>	<b>CURRENT LEVEL</b>	Current level selectable via DIP switch, please refer to "DIP SWITCH TABLE" section					
		350mA	500mA	600mA	700mA(default)	900mA	1050mA
	<b>RATED POWER</b>	42W					
	<b>DC VOLTAGE RANGE</b>	2 ~ 100V	2 ~ 80V	2 ~ 67V	2 ~ 57V	2 ~ 45V	2 ~ 40V
	<b>OPEN CIRCUIT VOLTAGE (max.)</b>	110V			65V		
	<b>CURRENT RIPPLE</b> Note.5	5.0% max. @rated current					
	<b>CURRENT TOLERANCE</b>	±5%					
	<b>AUXILIARY DC OUTPUT</b>	Nominal 12V(deviation 11.4~12.6V)@50mA					
<b>SETUP TIME</b> Note.3	500ms / 230VAC						
<b>INPUT</b>	<b>VOLTAGE RANGE</b> Note.2	180 ~ 295VAC 254 ~ 417VDC (Please refer to "STATIC CHARACTERISTIC" section)					
	<b>FREQUENCY RANGE</b>	47 ~ 63Hz					
	<b>POWER FACTOR (Typ.)</b>	PF≥0.975/230VAC, PF≥0.96/277VAC @full load (Please refer to "POWER FACTOR (PF) CHARACTERISTIC" section)					
	<b>TOTAL HARMONIC DISTORTION</b>	THD< 20%(@load≥75%) (Please refer to "TOTAL HARMONIC DISTORTION(THD)" section)					
	<b>EFFICIENCY (Typ.)</b> Note.4	91%					
	<b>AC CURRENT (Typ.)</b>	0.23A/230VAC 0.2A/277VAC					
	<b>INRUSH CURRENT (Typ.)</b>	COLD START 20A(twidth=260µs measured at 50% Ipeak) at 230VAC; Per NEMA 410					
	<b>MAX. No. of PSUs on 16A CIRCUIT BREAKER</b>	26 units (circuit breaker of type B) / 44 units (circuit breaker of type C) at 230VAC					
	<b>LEAKAGE CURRENT</b>	<0.5mA / 240VAC					
	<b>STANDBY POWER CONSUMPTION</b> Note.6	<1W					
<b>PROTECTION</b>	<b>SHORT CIRCUIT</b>	Constant current limiting, recovers automatically after fault condition is removed					
	<b>OVER VOLTAGE</b>	110 ~ 130V					
		Shutdown o/p voltage, re-power on to recover					
<b>OVER TEMPERATURE</b>	Shutdown o/p voltage, re-power on to recover						
<b>FUNCTION</b>	<b>WIRELESS PROTOCOL(Optional)</b>	EnOcean standard 868 MHz; Max. device(switch) saved into the memory : 33					
	<b>DIMMING</b>	Please refer to "DIMMING OPERATION" section					
	<b>SYNCHRONIZATION</b>	Please refer to "SYNCHRONIZATION OPERATION" section					
	<b>TEMP. COMPENSATION</b>	By external NTC, please refer to "TEMPERATURE COMPENSATION OPERATION" section					
<b>ENVIRONMENT</b>	<b>WORKING TEMP.</b>	Tcase=-30 ~ +90°C (Please refer to " OUTPUT LOAD vs TEMPERATURE" section)					
	<b>MAX. CASE TEMP.</b>	Tcase=+90°C					
	<b>WORKING HUMIDITY</b>	20 ~ 90% RH non-condensing					
	<b>STORAGE TEMP., HUMIDITY</b>	-40 ~ +80°C, 10 ~ 95% RH					
	<b>TEMP. COEFFICIENT</b>	±0.03%/°C (0 ~ 40°C)					
<b>VIBRATION</b>	10 ~ 500Hz, 2G 10min./1cycle, period for 60min. each along X, Y, Z axes						
<b>SAFETY &amp; EMC</b>	<b>SAFETY STANDARDS</b>	UL8750, CSA C22.2 No.250.13-12, ENEC EN61347-1, EN61347-2-13, EN62384 independent,GB19510.14,GB19510.1, BIS IS15885, EAC TP TC 004 approved					
	<b>WITHSTAND VOLTAGE</b>	I/P-O/P:3.75KVAC					
	<b>ISOLATION RESISTANCE</b>	I/P-O/P:>100M Ohms / 500VDC / 25°C / 70% RH					
	<b>EMC EMISSION</b> Note.7	Compliance to EN55015, EN61000-3-2 Class C(@load ≥ 40%) ; EN61000-3-3; GB17625.1,GB17743, EAC TP TC 020					
	<b>EMC IMMUNITY</b>	Compliance to EN61000-4-2,3,4,5,6,8,11, EN61547, light industry level(surge immunity Line-Line 2KV), EAC TP TC 020					
<b>OTHERS</b>	<b>MTBF</b>	260.6K hrs min. MIL-HDBK-217F (25°C)					
	<b>DIMENSION</b>	123.5*81.5*23mm (L*W*H)					
	<b>PACKING</b>	0.24Kg ; 54pcs/15Kg/1.12CUFT					
<b>NOTE</b>	<ol style="list-style-type: none"> <li>All parameters NOT specially mentioned are measured at 230VAC input, rated current and 25°C of ambient temperature.</li> <li>De-rating may be needed under low input voltages. Please refer to "STATIC CHARACTERISTIC" sections for details.</li> <li>Length of set up time is measured at first cold start. Turning ON/OFF the driver may lead to increase of the set up time.</li> <li>Efficiency is measured at 900mA/67V output set by DIP switch.</li> <li>Current ripple is measured 60%~100% of maximum voltage under rated power delivery.</li> <li>Standby power consumption is measured at 180~230VAC.</li> <li>The driver is considered as a component that will be operated in combination with final equipment. Since EMC performance will be affected by the complete installation, the final equipment manufacturers must re-qualify EMC Directive on the complete installation again.</li> <li>To fulfill requirements of the latest ErP regulation for lighting fixtures, this LED driver can only be used behind a switch without permanently connected to the mains.</li> <li>The ambient temperature derating of 3.5°C/1000m with fanless models and of 5°C/1000m with fan models for operating altitude higher than 2000m(6500ft).</li> </ol>						

**■ BLOCK DIAGRAM**

PFC fosc : 60KHz  
PWM fosc : 80KHz

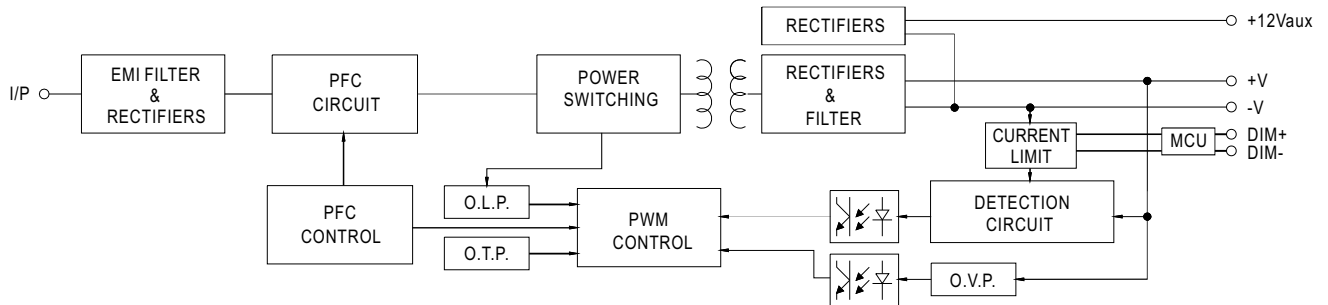

**■ DIP SWITCH TABLE**

LCM-40 is a multiple-stage constant current driver, selection of output current through DIP switch is exhibited below.

Io \ DIP S.W.	1	2	3	4	5	6
350mA	----	----	----	----	----	----
500mA	ON	----	----	----	----	----
600mA	ON	ON	----	----	----	----
700mA(factory default)	ON	ON	ON	----	----	ON
900mA	ON	ON	ON	ON	----	ON
1050mA	ON	ON	ON	ON	ON	ON

**■ DIMMING OPERATION**

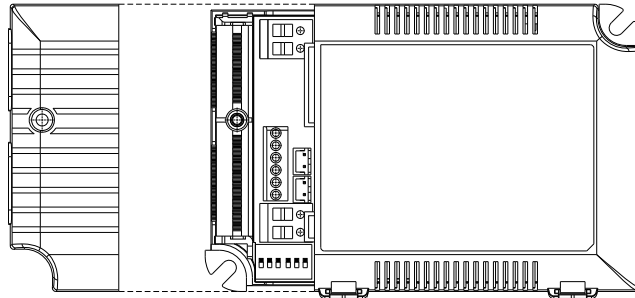

※ 3 in 1 dimming function

- Output constant current level can be adjusted by applying one of the three methodologies between DIM+ and DIM-: 0 ~ 10VDC, or 10V PWM signal or resistance. For optional EO model, the 3 in 1 dimming is via SYNC+ and SYNC-(CN100 or CN101 connector).
- Direct connecting to LEDs is suggested. It is not suitable to be used with additional drivers.
- Dimming source current from power supply: 100 $\mu$ A (typ.)

◎ Applying additive 0 ~ 10VDC

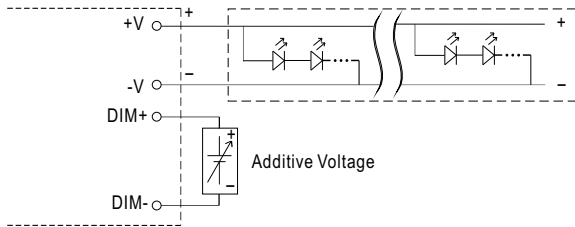

"DO NOT connect "DIM- to -V"

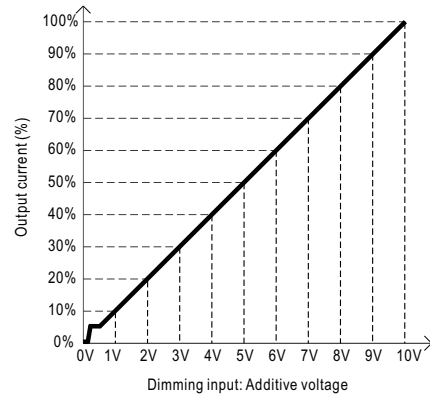

◎ Applying additive 10V PWM signal (frequency range 100Hz ~ 3KHz):

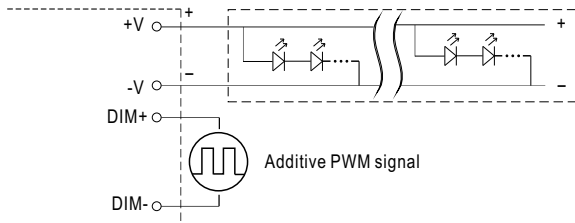

"DO NOT connect "DIM- to -V"

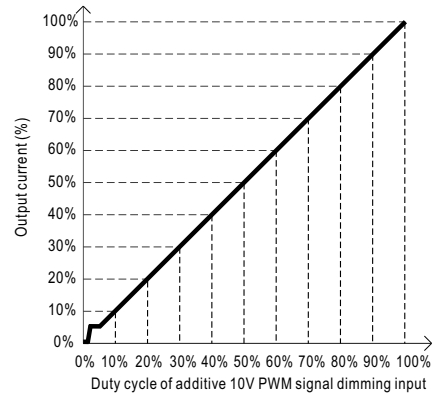

◎ Applying additive resistance:

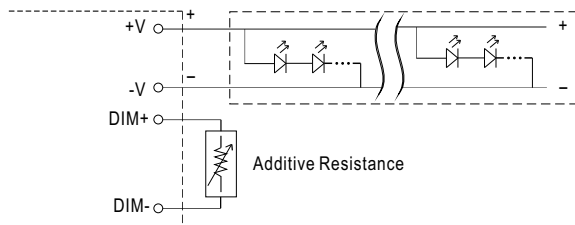

"DO NOT connect "DIM- to -V"

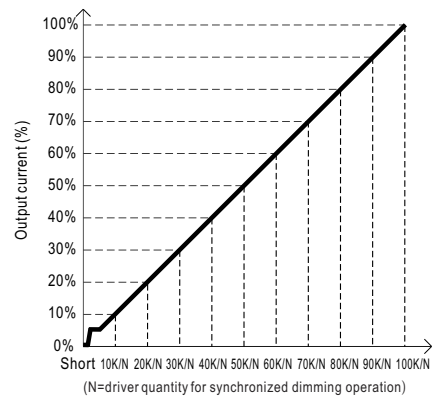

- Note :
1. Min. dimming level is about 6% and the output current is not defined when  $0\% < I_{out} < 6\%$ .
  2. The output current could drop down to 0% when dimming input is about 0k $\Omega$  or 0Vdc, or 10V PWM signal with 0% duty cycle.
  3. Please do not activate "temperature compensation" when performing dimming operation.

**■ SYNCHRONIZATION OPERATION**

- Synchronization up to 10 drivers (1 master + 9 slaves)
- Dimming operating range : 10%~100%
- Sync cable length : < 5m
- Sync cable type : Flat cable
- Sync cable cross section area : 22 – 24 AWG (0.2~0.3mm<sup>2</sup>)

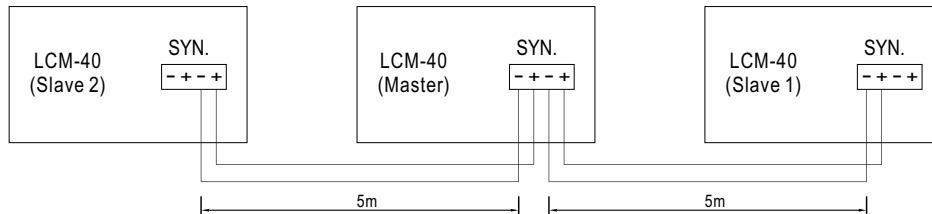

- NOTE: 1. Please make sure all units are set to 100% dimming setting (factory default) before synchronizing.  
 2. For optional EO model: the master is EO and the slave could be standard model for economic arrangement.  
 3. Min. Dimming operating range depends on dimmer setting.

**■ TEMPERATURE COMPENSATION OPERATION**

LCM-40 have the built-in temperature compensation function ; by connecting a temperature sensor (NTC resistor) between the +NTC / -NTC terminal of LCM-40 and the detecting point on the lighting system or the surrounding environment, output current of LCM-40 could be correspondingly changed, based on the sensed temperature, to ensure the long life of LED.

**NTC derating curve**

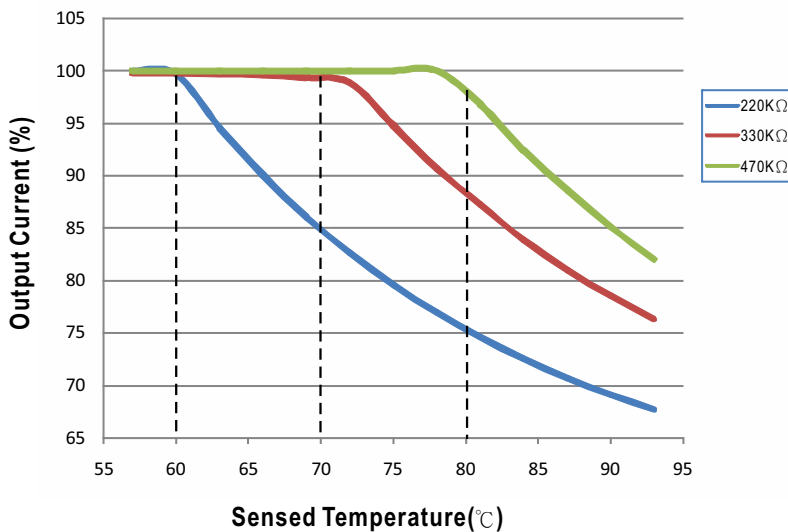

- ⊙ LCM-40 can still be operated normally when the NTC resistor is not connected and the value of output current will be the current level selected through the DIP switch.
- ⊙ NTC reference:

NTC resistance	Output Current
220K	< 60°C, 100% of the rated current (corresponds to the setting current level) > 60°C, output current begins to reduce, please refer to the curve for details.
330K	< 70°C, 100% of the rated current (corresponds to the setting current level) > 70°C, output current begins to reduce, please refer to the curve for details.
470K	< 80°C, 100% of the rated current (corresponds to the setting current level) > 80°C, output current begins to reduce, please refer to the curve for details.

- Notes: 1. MEAN WELL does not offer the NTC resistor and all the data above are measured by using THINKING TTC03 series.  
 2. If other brands of NTC resistor is applied, please check the temperature curve first.

- ⊙ Dimming and synchronization function of the driver will be invalid when the "temperature compensation" function is in use.

■ **OUTPUT LOAD vs TEMPERATURE**

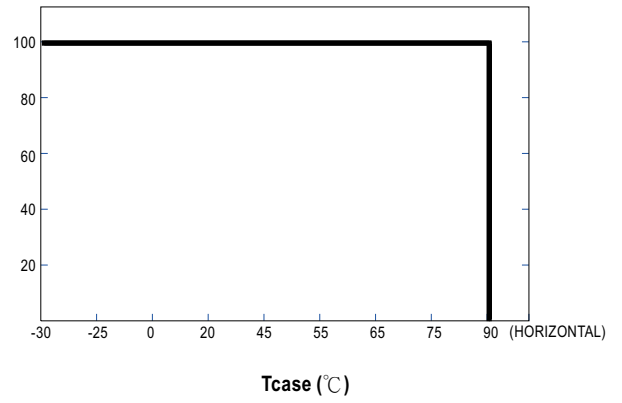
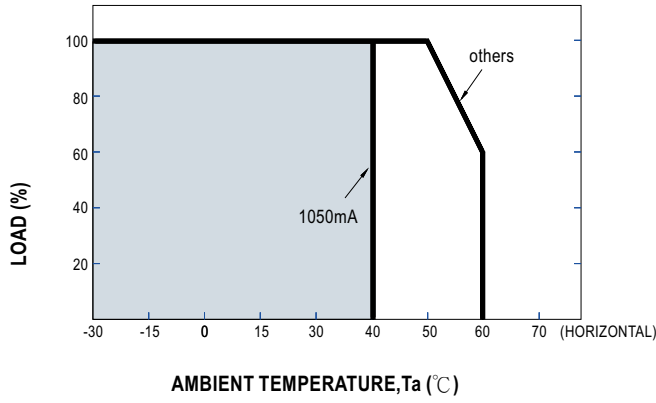

■ **STATIC CHARACTERISTIC**

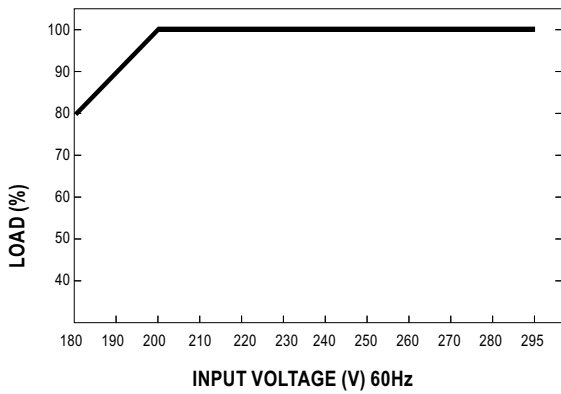

※ De-rating is needed under low input voltage.

**TOTAL HARMONIC DISTORTION (THD)**

※ Tcase at 80°C

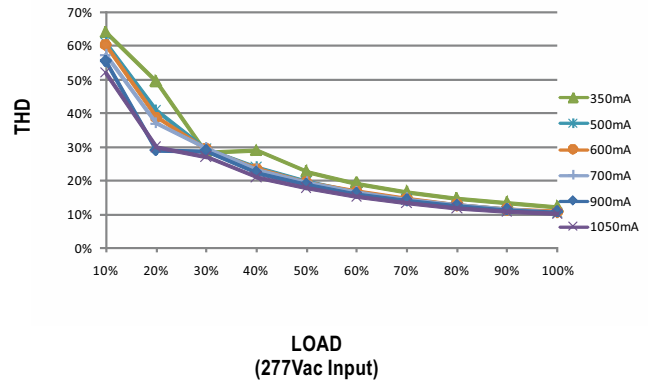
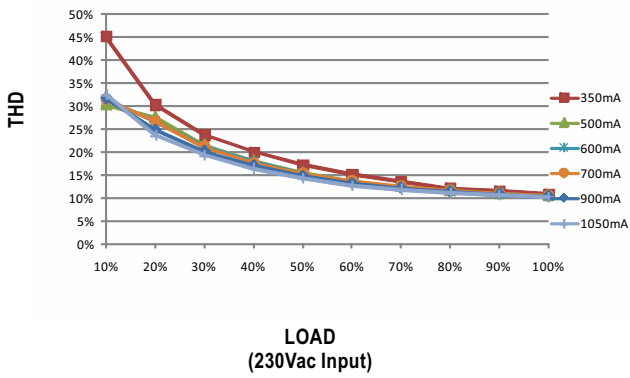

**POWER FACTOR (PF) CHARACTERISTIC**

※ Tcase at 80°C

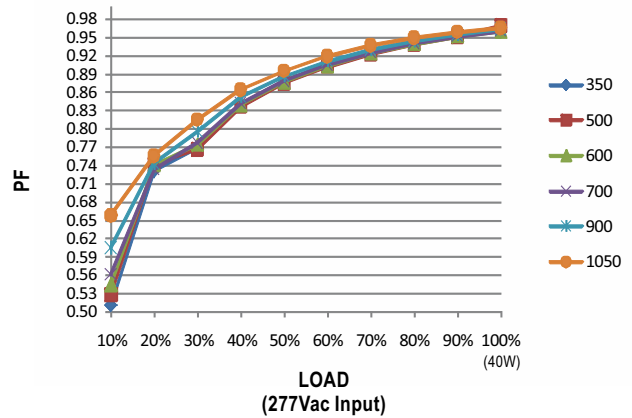
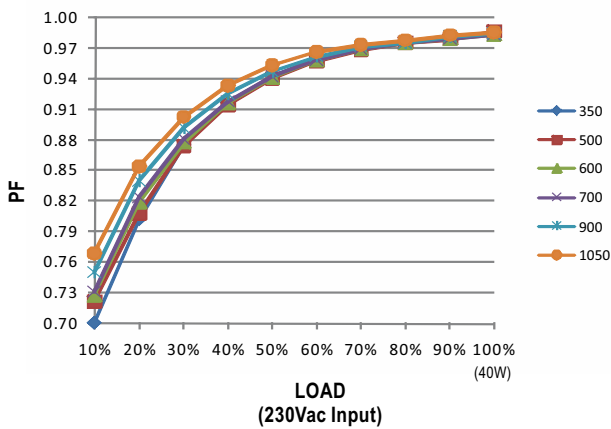

**EFFICIENCY vs LOAD**

LCM-40 series possess superior working efficiency that up to 91% can be reached in field applications.

※ Tcase at 80°C

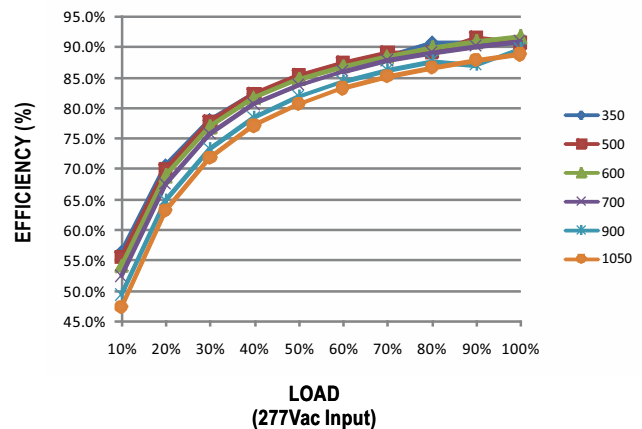
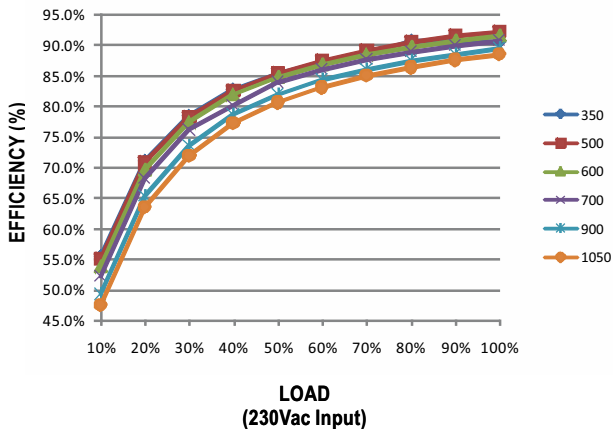

**MECHANICAL SPECIFICATION**

Case No.LCM-60A Unit:mm

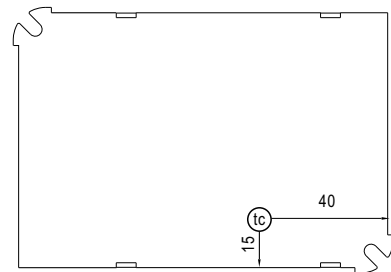
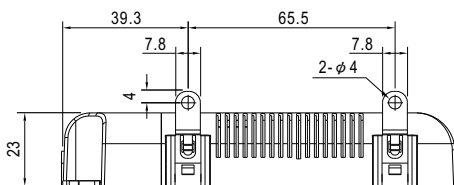
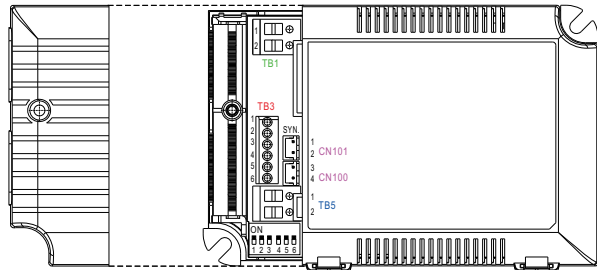
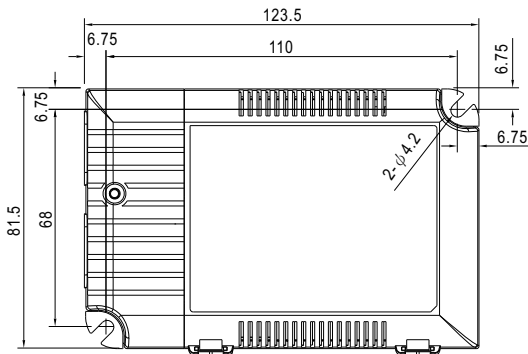

Bottom View

• (tc) : Max. Case Temperature

※ Terminal Pin No. Assignment(TB1)

Pin No.	Assignment
1	AC/L
2	AC/N

※ Terminal Pin No. Assignment(TB3)

Pin No.	Assignment	Pin No.	Assignment	Pin No.	Assignment
1	+FAN	3	+NTC	5	DIM+
2	-FAN	4	-NTC	6	DIM-

◎ Pin1(+FAN) / Pin2(-FAN) is the Auxiliary DC output;it can be used to drive fan.

※ Terminal Pin No. Assignment(TB5)

Pin No.	Assignment
1	+V
2	-V

※ SYN. Connector(CN101/CN100):JST B2B-XH or equivalent

Pin No.	Assignment	Mating Housing	Terminal
1,3	+	JST XHP or equivalent	JST SXH-001T-P0.6 or equivalent
2,4	-		

**Installation Manual**

Please refer to : <http://www.meanwell.com/manual.html>



※ The following is only for Optional EO model:

### ■ LRN button description

LRN (Learn) Button:

Shortly press (around 2 second) the button to enter linking (pairing) / unlinking mode.

The LED lamp connected at the output of LCM starts toggling between 10% and 90% indicating that linking mode is active. Once activated, this mode stays active to provide time to link or unlink multiple switches. The mode will stop and back to normal mode after 30 seconds if no wireless telegram from switch is received.

For the switch to be linked, click the "I" button (top button marked on the switch plastic or "I" symbol on the back of the switch 4 times quickly, In case the output is continuous 100% 4 seconds, it mean the switch is linked successfully.

The LED driver is now ready to accept new links on another switch.

In case a linked switch to be unlinked, please use the same action as described from the linking method above.

To exit linking / unlinking mode and return to normal operation, wait 30 seconds without doing anything or shortly press the button again.

In order to clear all linked switches and reset the LED driver to factory settings, please press and hold the button for 10 seconds.

### ■ Installation & Pairing

Hardware connection:

- 1.Connect the LED lamp to the driver.
- 2.Connect the driver to the AC mains.

There are two approaches for linking(pairing):

- 1.Using the LRN button on the driver

The instruction is in the LRN button description.

- 2.Using the NAVIGAN wireless software

Benefit to use NAVIGAN is more dimming parameters can be configured .

The software can be download in the website link below.

<http://www.navigan.com/>

After the software installation, insert the NWC300 into one of USB port from the computer.

For more details, please check the manual.



NWC300

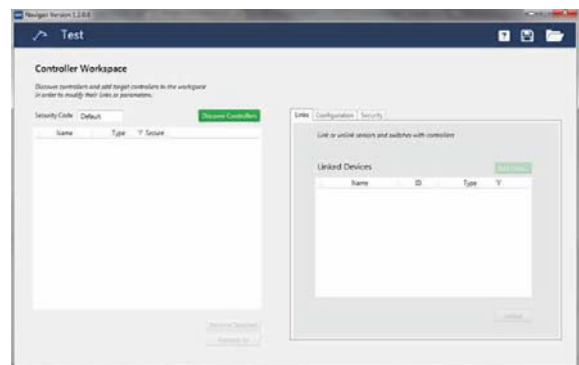

※The following is only for Optional EO model

Case No.LCM-60A Unit:mm

MECHANICAL SPECIFICATION

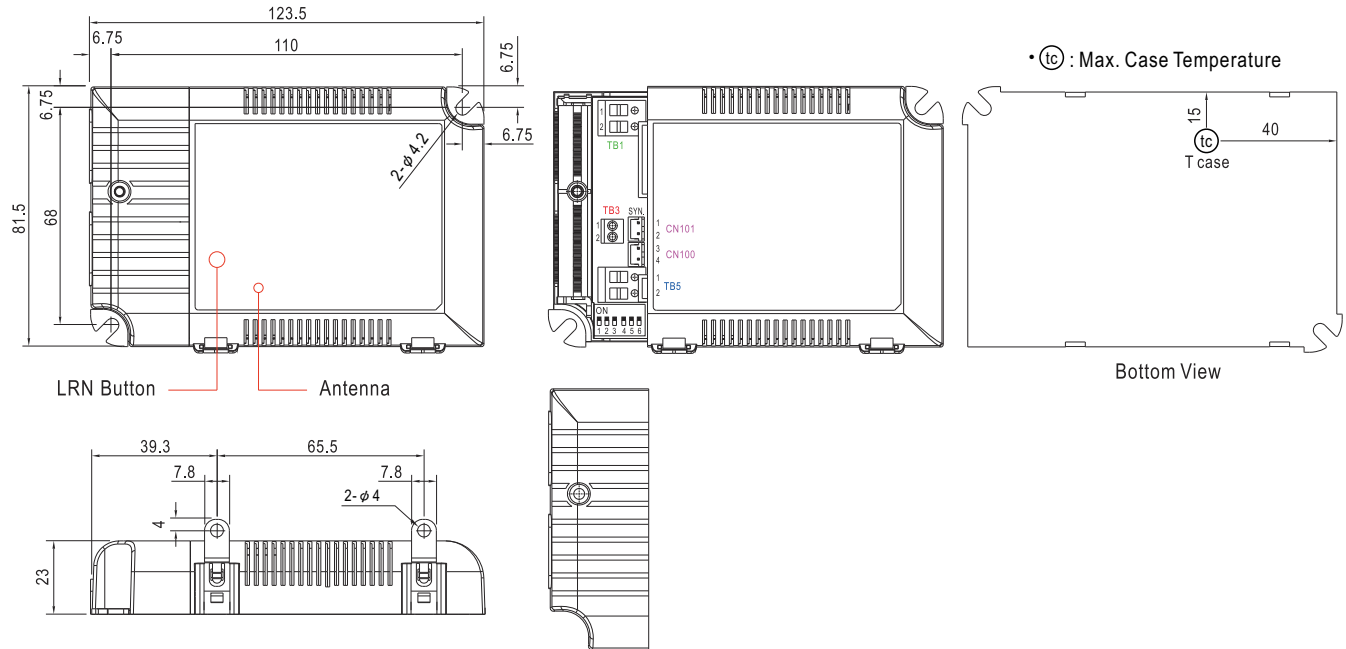

※ Terminal Pin No. Assignment(TB1)

Pin No.	Assignment
1	AC/L
2	AC/N

※ Terminal Pin No. Assignment(TB3)

Pin No.	Assignment
1	+NTC
2	-NTC

※ Terminal Pin No. Assignment(TB5)

Pin No.	Assignment
1	+Vo
2	-Vo

※ SYN. or DC 0-10V Dimming

Connector(CN101/CN100):JST B2B-XH or equivalent

Pin No.	Assignment	Mating Housing	Terminal
1,3	+	JST XHP or equivalent	JST SXH-001T-P0.6 or equivalent
2,4	-		

■ **Interoperable products / EnOcean Equipment Profile(EEP)**

Support Equipment	Telegram
Rocker Pad Switch	F6-02-02
Occupancy Sensor	F5-07-01
Occupancy Sensor	A5-07-02
Occupancy Sensor	A5-07-03
Light Level Sensor	A5-06-02
Light Level Sensor	A5-06-03
Central Controller	A5-38-08
Demand Response	A5-37-01

■ **Batteryless wireless switch supplier**

MW order code:WPD-06SWT. There are many other switch supplier listed in the below.



Manufacturer	Model*
Legrand	0 784 42
Siemens	5WG4222-3AB10
Berker	24121009
Jung	ENO A 595
Busch-jaeger	EASYSSENS/ENOCEAN
Gira	2422 03
Peha	D 455/61.022 FU-BLS N
Eltako	F4T65
VIMAR	20505+20506.B+21507.B

\*: The model list is rovided for reference. For more information please contact original supplier

**World Coverage Map**

COUNTRY/REGION	STANDARD	FREQUENCY
Aruba	Possibly R & TTE Directive	868 MHz-Confirm with test house
Australia / New Zealand	N.A.	
Barbados	N.A.	Note1
Bermuda	N.A.	Note1
Bolivia	N.A.	Note1
Brazil	ANATEL	868 MHz
British Virgin Islands	N.A.	Note1
Cayman Islands	Possibly R & TTE Directive	868 MHz
CEPT(European regional)*	EN 300 220	868 MHz
Chile	Possibly R & TTE Directive	868 MHz
China	CNAS/MITT EN 300 220	868 MHz
Colombia	Possibly ANATEL	868 MHz
Ecuador	N.A.	Note1
El Salvador	Possibly R & TTE Directive	868 MHz
French Guiana	ETSI EN 300 220	868 MHz
Guatemala	N.A.	Note1
Hong Kong	Possibly 315MHz	Note1
India	Possibly 315MHz	Note1
Israel	Possibly 315MHz	Note1
Jamaica	N.A.	Note1
Japan 920**	ARIB STD-T108	928 MHz
Malaysia	SKMM WTS SRD / EN 300 220	868 MHz
Mexico	We believe Mexico does not accept FCC	868 MHz
Nicaragua	N.A.	Note1
Peru	N.A.	Note1
Panama	FCC CFR47 Part 15.249	902 MHz
Russia	N.A.	
Singapore	TS SRD / EN 300 220	868 MHz
South Africa	CASA / EN 300 220	868 MHz
South Korea	N.A.	
Suriname	N.A.	Note1
Taiwan	Possibly 315 MHz	Note1
Trinidad & Tabago	N.A.	Note1
Turks & Caicos Islands	Possibly R & TTE Directive	868 MHz
UAE	EN 300 220	868 MHz
Uruguay	N.A.	Note1
USA / Canada	FCC CFR47 Part 15.249	315 MHz, 902 MHz

Note1: It is suggested to check with local accredited certification agency.

\*CEPT is the European regional organization dealing with postal and telecommunications issues and presently has 45 Members: Albania, Andorra, Austria, Azerbaijan, Belarus, Belgium, Bosnia and Herzegovina, Bulgaria, Croatia, Cyprus, Czech Republic, Denmark, Estonia, Finland, France, Germany, Greece, Hungary, Iceland, Ireland, Italy, Latvia, Liechtenstein, Lithuania, Luxembourg, Malta, Moldova, Monaco, Netherlands, Norway, Poland, Portugal, Romania, Russian Federation, San Marino, Serbia and Montenegro, Slovakia, Slovenia, Spain, Sweden, Switzerland, The former Yugoslav Republic of Macedonia, Turkey, Ukraine, United Kingdom, and Vatican.

\*\*In February 2012, Japanese regulatory body ARIB(Association of Radio Industries and Businesses) released new 920 MHz frequency band for radio equipment, due to LTE rollout, The 950 MHz frequency band will be obsolete by end of 2015.