



## DEW

EMMANUEL BABLED / 2009

EN: Suspension lamp with glass diffuser and die-casted aluminium heat sink. High voltage Power Led. It can be realized on demand as a multiple pendant chandelier.

IT: Lampada a sospensione con diffusore in vetro e dissipatore in alluminio pressofuso. Led a tensione di rete. Il prodotto si presta a composizioni multiple realizzabili a richiesta.

### CERTIFICATIONS / CERTIFICAZIONI



Product in class I  
Apparecchio di classe I

IP20

Product for indoor use  
Apparecchio per uso interno



Product in conformity with the European directive 2006/95/EC  
Apparecchio conforme alla direttiva europea 2006/95/EC



Product in conformity with the Eurasian Custom Unions technical regulations  
Apparecchio conforme ai regolamenti tecnici dell'Unione doganale Eurasiatica



USA and Canada conformity seal (Dew + Dew 3)  
Marchio di conformità USA e Canada (Dew + Dew 3)



This lamp must be disposed in conformity with the EU directive 2002/96/EC  
Apparecchio di illuminazione da smaltire secondo la direttiva EU 2002/96/EC

### CODES AND DIMENSIONS / CODICI E DIMENSIONI

#### DEW

0451291EU  
0451291NEU  
0451291OEU

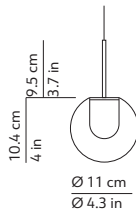

#### DEW FALSE CEILING

0451291C  
0451291CN  
0451291CO

#### DEW 3

0451293EU  
0451293NEU  
0451293OEU

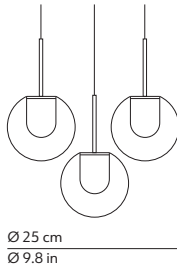

### PACKAGING / IMBALLO

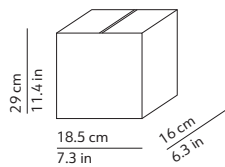

Volume: 0.009 m<sup>3</sup> / 0.303 ft<sup>3</sup>  
Gross weight: 2.34 kg / 5.15 lbs

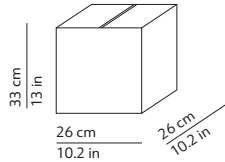

Volume: 0.022 m<sup>3</sup> / 0.788 ft<sup>3</sup>  
Gross weight: 6.72 kg / 14.78 lbs

### MATERIALS AND FINISHINGS / MATERIALI E FINITURE

#### DIFFUSER / DIFFUSORE

○ Transparent / Trasparente

Glass diffuser  
Diffusore in vetro

#### STRUCTURE / STRUTTURA

● Chrome / Cromo

● Black / Nero  
On request / Su richiesta

● Brass / Ottone  
On request / Su richiesta

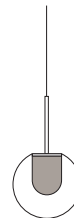

Die cast aluminium  
heat sink.  
Dissipatore in  
alluminio pressofuso.

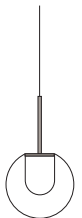



Metal tige  
Tige in metallo

**DEW**

230V  
or 120V Feeding / Alimentazione

Light source / Sorgente luminosa  
1 x 4.8W - 2700 K - 500 lm - CRI>90 - Board LED  
LED life expectancy 30 000 hours

 Energy efficiency class A+

 Dimmable / Dimmerabile  
Phase cut

 Suspension lamp  
Lampada a sospensione

Canopy - diam. 4.9in h. 1.2in  
chromed or black (on request) or brass (on request)  
fixed to the ceiling with not provided screws (2-4)  
Rosone - diam. 12.5cm h. 3cm  
cromato o nero (su richiesta) o ottone (su richiesta)  
fissato a soffitto con tasselli (2-4) non forniti

 Transparent cord set - length ca. 98.4 in  
different lengths on request  
Cavo di alimentazione trasparente - lunghezza ca. 250 cm  
altre lunghezze su richiesta

Multiple composition on demand  
Composizioni multiple su richiesta

**DEW FALSE CEILING**

230V  
or 120V Feeding / Alimentazione

Light source / Sorgente luminosa  
1 x 4.8W - 2700 K - 500 lm - Board LED  
LED life expectancy 30 000 hours

 Energy efficiency class A+

 Dimmable / Dimmerabile  
Phase cut

 Suspension lamp  
Lampada a sospensione

Canopy - diam. 3.2in h. 0.2in  
chromed or black (on request) or brass (on request)  
Rosone - diam. 8cm h. 0.6cm  
cromato o nero (su richiesta) o ottone (su richiesta)

 Transparent cord set - length ca. 98.4 in  
different lengths on request  
Cavo di alimentazione trasparente - lunghezza ca. 250 cm  
altre lunghezze su richiesta

**DEW 3**

230V  
or 120V Feeding / Alimentazione

Light source / Sorgente luminosa  
3 x 4.8W - 2700 K - 1500 lm - Board LED  
LED life expectancy 30 000 hours

 Energy efficiency class A+

 Dimmable / Dimmerabile  
Phase cut

 Suspension lamp  
Lampada a sospensione

Canopy - diam. 8in h. 1in  
chromed or black (on request) or brass (on request)  
fixed to the ceiling with not provided screws (2-4)  
Rosone - diam. 20.5cm h. 2.5cm  
cromato o nero (su richiesta) o ottone (su richiesta)  
fissato a soffitto con tasselli (2-4) non forniti

 Transparent cord set - length ca. 98.4 in  
different lengths on request  
Cavo di alimentazione trasparente - lunghezza ca. 250 cm  
altre lunghezze su richiesta

# kdl<sup>n</sup>

kundalini.it

ASSEMBLY INSTRUCTIONS  
ISTRUZIONI DI MONTAGGIO  
INSTRUCCIONES DE MONTAGE  
MONTAGE-ANLEITUNG  
INSTRUCCIONES DE MONTAJE  
ИНСТРУКЦИИ ПО МОНТАЖУ

# DEW

EMMANUEL BABLED

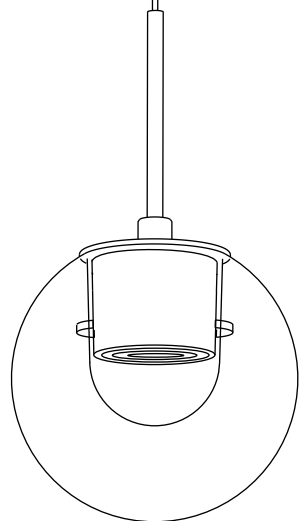

## WARNING

The safety is guaranteed by the appropriate use of the following instructions, so you must keep them. Always disconnect the main voltage before working on the appliance. Never use abrasive products or aggressive detergents for cleaning the lamp. If the external cable of this appliance is damaged, it must be replaced by the manufacturer, its after sales service or other equivalent qualified person only in order to avoid any danger. Kundalini will not provide a replacement until the nature of defect has been determined.

## ATTENZIONE

La sicurezza dell'apparecchio è garantita con l'uso appropriato delle seguenti istruzioni, pertanto è necessario conservarle. Togliere sempre la tensione prima di operare sull'apparecchio. Per pulire la lampada non usare mai prodotti abrasivi o detersivi aggressivi. Se il cavo esterno di questo apparecchio viene danneggiato, deve essere sostituito esclusivamente dal costruttore, dal suo servizio assistenza, o da personale qualificato equivalente, al fine di evitare pericoli. Kundalini non effettuerà nessuna sostituzione se non dopo aver accertato la natura del difetto.

## ATTENTION

La sûreté de l'appareil n'est garantie qu'en suivant scrupuleusement les instructions ci-après. Il est donc nécessaire de les conserver. Isoler l'appareil du secteur avant toute manipulation. Pour nettoyer la lampe, ne jamais utiliser de produits abrasifs ou de nettoyeurs agressifs. Si le câble externe de cet appareil est endommagé, il doit être remplacé uniquement par les soins du constructeur, par son service après-vente ou bien par le personnel équivalent, et ce afin d'éviter tout danger. Kundalini ne remplacera aucun appareil sans en avoir pu vérifier le défaut.

## ACHTUNG

Die Sicherheit dieses Artikels wird nur durch die strikte Befolgung der nachfolgenden Betriebsanleitung gewährleistet. Bitte heben Sie diese unbedingt auf. Vor allen Arbeiten ziehen Sie bitte den Stecker aus der Dose. Für die Reinigung der Lampe niemals Schleifmittel oder aggressive Reinigungsmittel verwenden. Sollte das Außenkabel der Lampe beschädigt werden, ist es ausschließlich vom Service-Dienst des Herstellers oder gleichwertigen, qualifiziertem Personal auszutauschen, um somit Gefahren zu vermeiden. Kundalini leistet grundsätzlich erst nach einer gründlichen Überprüfung Ersatz.

## ATENCIÓN

La seguridad del aparato está garantizada sólo con el uso apropiado de las instrucciones siguientes, por lo tanto es necesario atenderlas puntualmente. Desconectar siempre la alimentación antes de trabajar en el aparato. Nunca utilice productos abrasivos o detergentes agresivos para limpiar la lámpara. Si el cable externo de este aparato se deteriora será necesario sustituirlo; la sustitución podrá efectuarla exclusivamente el fabricante, su servicio de asistencia o personal cualificado equivalente para evitar peligros. Kundalini no efectuará sustitución alguna hasta después de haber verificado la naturaleza del defecto.

## ВНИМАНИЕ!

Безопасность прибора обеспечивается за счет правильного пользования настоящими инструкциями, поэтому необходимо их сохранять. Перед началом работы на приборе всегда отключать напряжение. Для очистки лампы не использовать абразивные продукты или агрессивные чистящие средства. Если внешний кабель прибора поврежден, во избежание опасностей он должен быть заменен только изготовителем, его сервисной службой или равнозначным квалифицированным персоналом. Kundalini не выполняет никаких замен, если не было установлено происхождение дефекта.



IP20



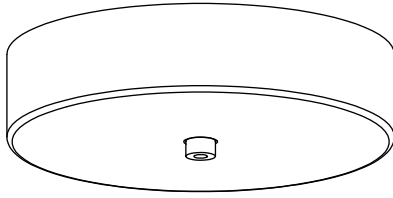

Protezione  
Protection  
Schutz  
Protection  
Protección

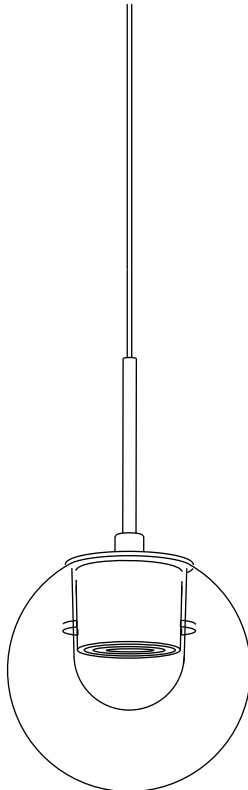

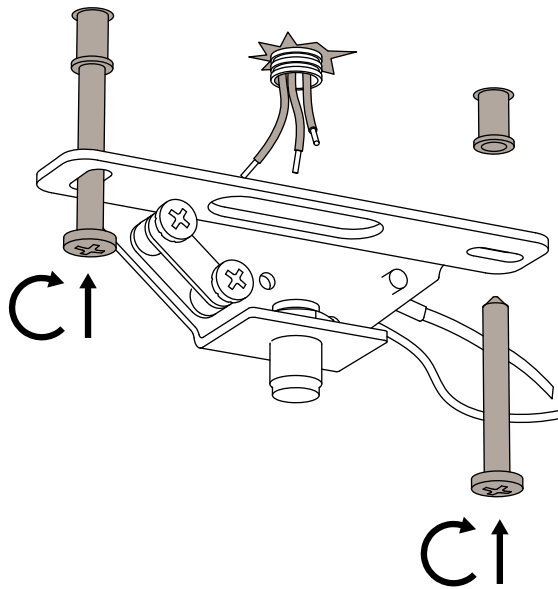

.1

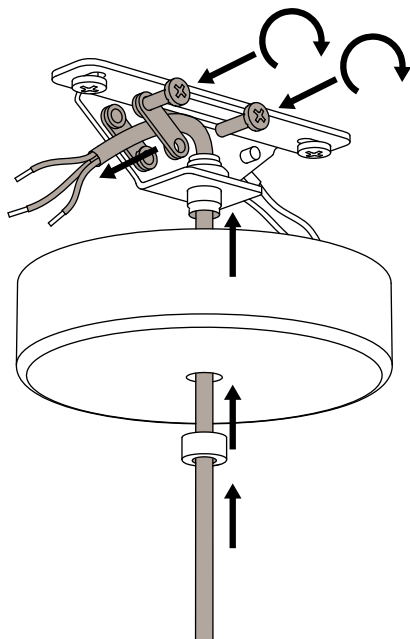

.2

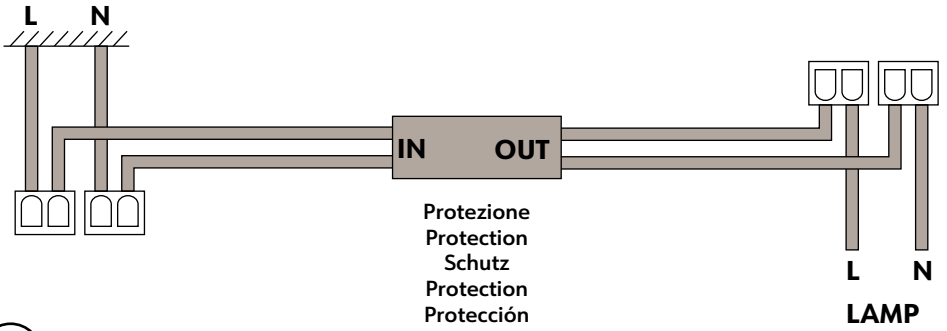

.3

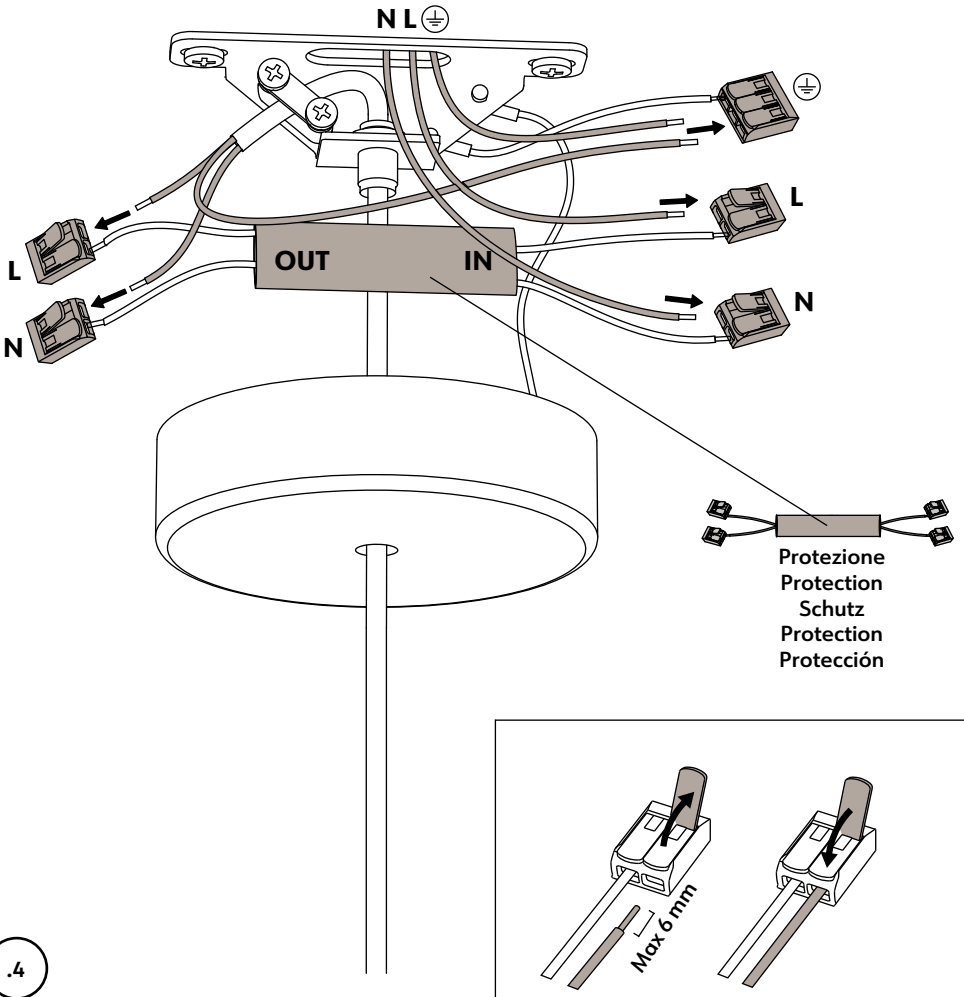

.4

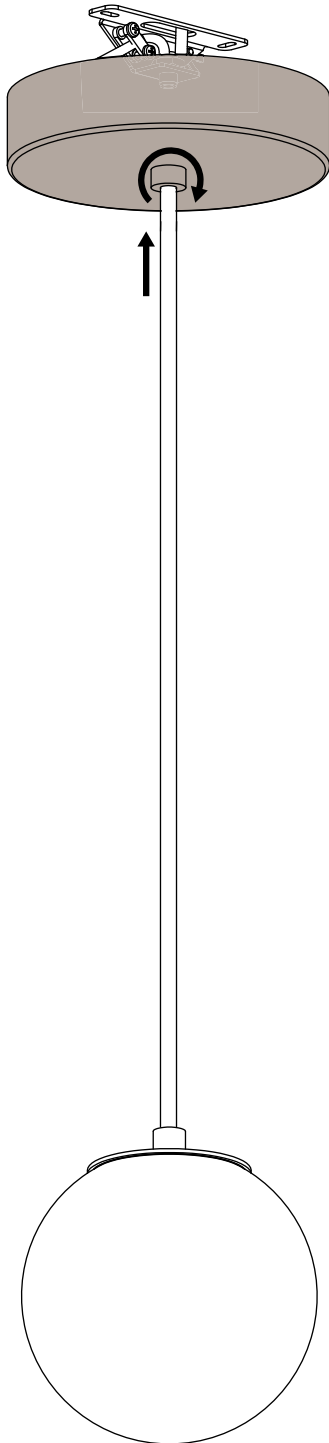



**BULBS, LAMPADINE, AMPOULES, LEUCHTENMITTEL, BOMBILLAS, ТИП ЛАМПОЧКИ**

board LED 1 x 4,8W - 2700K - 500lm - dimmable phase cut

Energy efficiency class A+

**FEEDING, ALIMENTAZIONE, ALIMENTATION, SPANNUNG, TENSION DE RED, НАПРЯЖЕНИЕ**

220-240 / 120 V

