

EN. Table lamp with rechargeable battery. Opal diffuser made of two layers of mouth blown glass. Metallic body available in three coating finishes: black, copper and brass.

IT. Lampada da tavolo con batteria ricaricabile. Diffusore in vetro opale incamiciato e soffiato. Struttura in metallo verniciato in tre versioni: nero, rame e ottone.



CERTIFICATIONS / CERTIFICAZIONI



Product in class III
Apparecchio di classe III

IP20

Product for indoor use
Apparecchio per uso interno



Product in conformity with the European directive 2006/95/EC
Apparecchio conforme alla direttiva europea 2006/95/EC



Product in conformity with the Eurasian Custom Unions technical regulations
Apparecchio conforme ai regolamenti tecnici dell'Unione doganale Eurasiatca



This lamp must be disposed in conformity with the EU directive 2002/96/EC
Apparecchio di illuminazione da smaltire secondo la direttiva EU 2002/96/EC

CODES AND DIMENSIONS / CODICI E DIMENSIONI

K2291059N
K2291059O
K2291059R

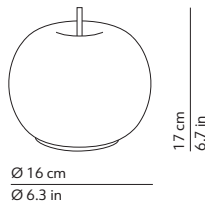

PACKAGING / IMBALLO

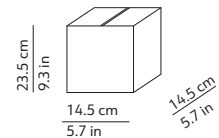
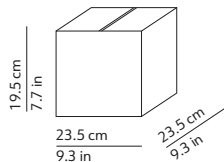

Diffuser
Volume: 0.011 m³ / 0.380 ft³
Gross weight: 0.86 kg / 1.89 lbs

Structure
Volume: 0.005 m³ / 0.174 ft³
Gross weight: 0.42 kg / 0.92 lbs

MATERIALS AND FINISHINGS / MATERIALI E FINITURE

DIFFUSER / DIFFUSORE



White / Bianco

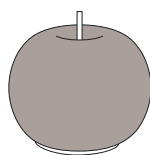

Two layers of mouth blown glass
Vetro opale incamiciato e soffiato

STRUCTURE / STRUTTURA



Black / Nero
Matt / Opaco



Brass / Ottone
Shiny / Lucido



Copper / Rame
Shiny / Lucido

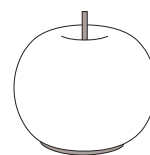

Liquid varnished metallic tige
Tige in metallo verniciato



White / Bianco

White metallic base
Base in metallo bianco

FURTHER INFORMATION / INFORMAZIONI AGGIUNTIVE

5V
min
500 mA Feeding / Alimentazione

Light source / Sorgente luminosa
1 x 1.3W - 2700K - 150lm - CRI>80 - Board LED

Energy efficiency class A+

Dimmer / Varialuce
No

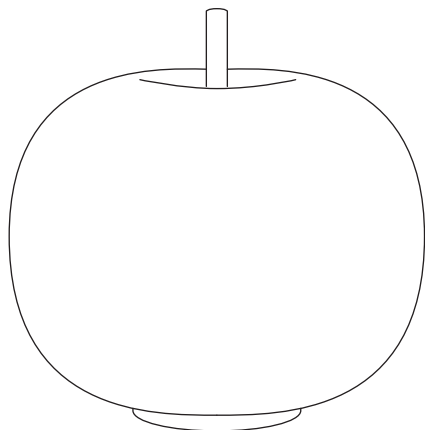

Table lamp
Lampada da tavolo



Rechargeable Battery
Autonomy: 5h 30min - charge time: 4 hours - charge cable included
(39.4in)
Batteria Ricaricabile
Autonomia: 5h 30min - tempo di carica: 4 ore - cavo caricabatteria incluso
(100cm)

ASSEMBLY INSTRUCTIONS
ISTRUZIONI DI MONTAGGIO
INSTRUCCIONES DE MONTAGE
MONTAGE-ANLEITUNG
INSTRUCCIONES DE MONTAJE
ИНСТРУКЦИИ ПО МОНТАЖУ



KUSHI MOBILE

ALBERTO SAGGIA
& VALERIO SOMMELLA

WARNING

The safety is guaranteed by the appropriate use of the following instructions, so you must keep them. Always disconnect the main voltage before working on the appliance. Never use abrasive products or aggressive detergents for cleaning the lamp. If the external cable of this appliance is damaged, it must be replaced by the manufacturer, its after sales service or other equivalent qualified person only in order to avoid any danger. Kundalini will not provide a replacement until the nature of defect has been determined.

ATTENZIONE

La sicurezza dell'apparecchio è garantita con l'uso appropriato delle seguenti istruzioni, pertanto è necessario conservarle. Togliere sempre la tensione prima di operare sull'apparecchio. Per pulire la lampada non usare mai prodotti abrasivi o detersivi aggressivi. Se il cavo esterno di questo apparecchio viene danneggiato, deve essere sostituito esclusivamente dal costruttore, dal suo servizio assistenza, o da personale qualificato equivalente, al fine di evitare pericoli. Kundalini non effettuerà nessuna sostituzione se non dopo aver accertato la natura del difetto.

ATTENTION

La sûreté de l'appareil n'est garantie qu'en suivant scrupuleusement les instructions ci-après. Il est donc nécessaire de les conserver. Isoler l'appareil du secteur avant toute manipulation. Pour nettoyer la lampe, ne jamais utiliser de produits abrasifs ou de nettoyeurs agressifs. Si le câble externe de cet appareil est endommagé, il doit être remplacé uniquement par les soins du constructeur, par son service après-vente ou bien par le personnel équivalent, et ce afin d'éviter tout danger. Kundalini ne remplacera aucun appareil sans en avoir pu vérifier le défaut.

ACHTUNG

Die Sicherheit dieses Artikels wird nur durch die strikte Befolgung der nachfolgenden Betriebsanleitung gewährleistet. Bitte heben Sie diese unbedingt auf. Vor allen Arbeiten ziehen Sie bitte den Stecker aus der Dose. Für die Reinigung der Lampe niemals Schleifmittel oder aggressive Reinigungsmittel verwenden. Sollte das Außenkabel der Lampe beschädigt werden, ist es ausschließlich vom Service-Dienst des Herstellers oder gleichwertigen, qualifiziertem Personal auszutauschen, um somit Gefahren zu vermeiden. Kundalini leistet grundsätzlich erst nach einer gründlichen Überprüfung Ersatz.

ATENCIÓN

La seguridad del aparato está garantizada sólo con el uso apropiado de las instrucciones siguientes, por lo tanto es necesario atenderlas puntualmente. Desconectar siempre la alimentación antes de trabajar en el aparato. Nunca utilice productos abrasivos o detergentes agresivos para limpiar la lámpara. Si el cable externo de este aparato se deteriora será necesario sustituirlo; la sustitución podrá efectuarla exclusivamente el fabricante, su servicio de asistencia o personal cualificado equivalente para evitar peligros. Kundalini no efectuará sustitución alguna hasta después de haber verificado la naturaleza del defecto.

ВНИМАНИЕ!

Безопасность прибора обеспечивается за счет правильного пользования настоящими инструкциями, поэтому необходимо их сохранять. Перед началом работы на приборе всегда отключать напряжение. Для очистки лампы не использовать абразивные продукты или агрессивные чистящие средства. Если внешний кабель прибора поврежден, во избежание опасностей он должен быть заменен только изготовителем, его сервисной службой или равнозначным квалифицированным персоналом. Kundalini не выполняет никаких замен, если не было установлено происхождение дефекта.



IP20



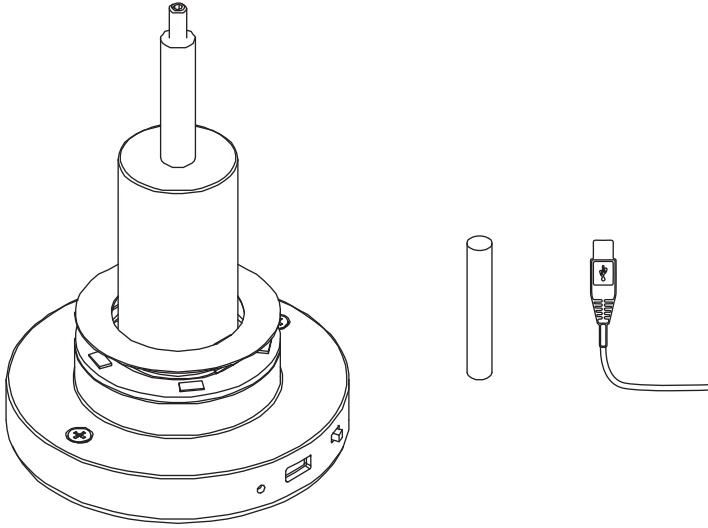

BOX N.1

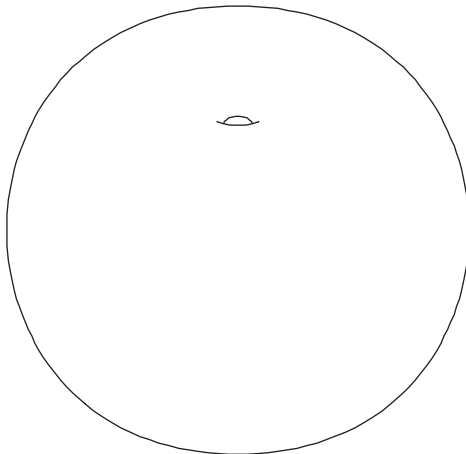

BOX N.2

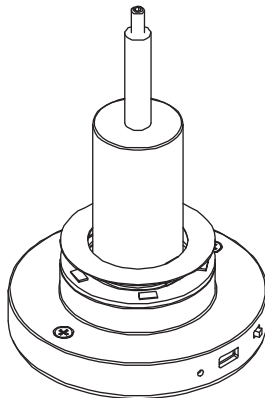
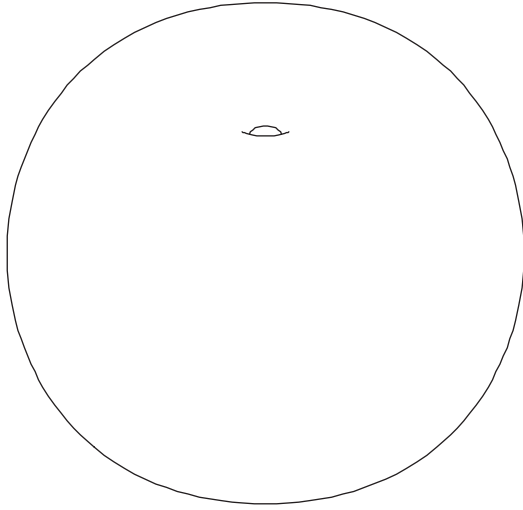

.1

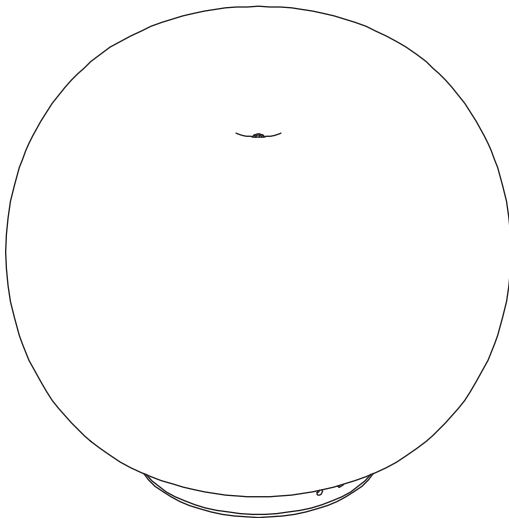

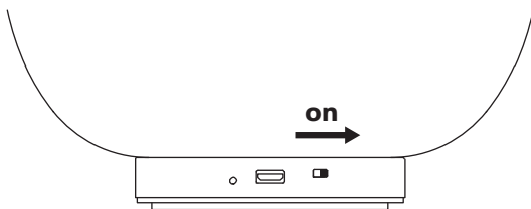
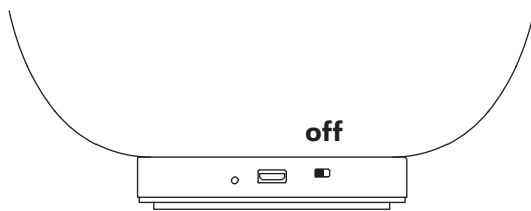

.3

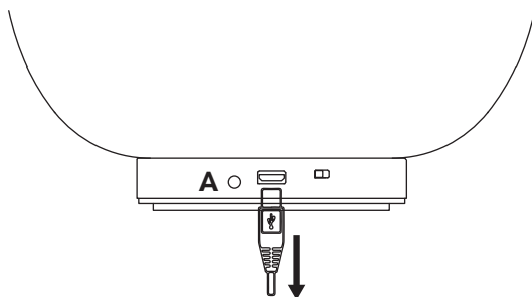
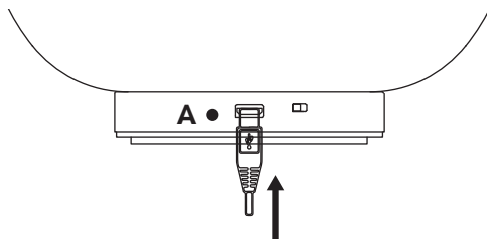

.4

ISTRUZIONI DI MONTAGGIO

Inserire il diffusore sulla struttura elettrica. Fissare avvitando la tige sull'estremità della struttura elettrica fino al punto in cui il diffusore risulta bloccato.

Modalità di utilizzo

Accendere la lampada tramite l'interruttore posto sulla base della lampada. Per ricaricare la lampada collegarla tramite il cavo USB fornito (tipo Micro-B) a un caricabatterie e lasciarla in carica. La carica è completa quando la luce **A** è spenta.

ASSEMBLY INSTRUCTIONS

Insert the diffuser upon the electrical structure. Fix screwing the tige on the top of the electrical structure to the point where the diffuser is blocked.

How to use

Switch on the lamp with the switch positioned on the base of the lamp. To recharge the lamp insert the supplied USB cable (Micro-B type) in a charger and leave it charging. The charge is complete when the light **A** is turned off.

MONTAGE-ANLEITUNG

Setzen Sie den Glasschirm auf die elektrische Struktur. Sichern Sie diesen indem Sie den Metallstift an das Ende der elektrischen Struktur festschrauben bis der Glasschirm fest sitzt.

Modalitäten der Verwendung

Schalten Sie die Leuchte mittels Schalter welcher sich auf dem Sockel der Lampe befindet ein. Zum Aufladen der Leuchte mittels beigefügtem USB-Kabel (Micro-B-Typen) stecken Sie das Netzteil des Ladegeräts in die dazugehörige Öffnung am Sockel und laden Sie die Leuchte es bis zu dem Moment, in dem das Licht **A** erlischt.

INSTRUCTIONS DE MONTAGE

Insérer le diffuseur sur la structure électrique. Fixer en vissant la tige inférieure à l'extrémité de la structure électrique jusqu'à ce que le diffuseur se bloque.

Mode d'utilisation

Allumer la lampe avec l'interrupteur sur la base de la lampe. Pour recharger la lampe se connecter via le câble USB (type Micro-B) à un chargeur. La charge est terminée lorsque la lumière **A** est éteinte.

INSTRUCCIONES DE MONTAJE

Insertar el difusor en la estructura eléctrica. Fijar enroscando el tubo inferior en la extremidad de la estructura eléctrica hasta el punto en el cual el difusor resulta bloqueado.

Modalidades de utilización

Encender la lámpara a través del interruptor colocado en la base de la lámpara. Para recargar la lámpara conectarla mediante el cable USB suministrado (tipo Micro-B) a un cargador y cargarla. La lámpara está completamente cargada cuando la luz **A** esté apagada.

ИНСТРУКЦИИ ПО МОНТАЖУ

Установить диффузор на электрическую конструкцию. Закрепить путем закручивания стержня на конце электрической конструкции до тех пор, пока диффузор не будет заблокирован.

Способ использования

Включить лампу с помощью выключателя на основании лампы. Для зарядки лампы подсоединить ее с помощью кабеля USB из комплекта поставки (тип Micro-B) к зарядному устройству и оставить на зарядке. Зарядка завершена, когда подсветка **A** гаснет.

BULBS, LAMPADINE, AMPOULES, LEUCHTENMITTEL, BOMBILLAS, ТИП ЛАМПОЧКИ

board LED 1 x 1,3W - 2700K - 150lm

Energy efficiency class A+

FEEDING, ALIMENTAZIONE, ALIMENTATION, SPANNUNG, TENSION DE RED, НАПРЯЖЕНИЕ

5V min 500mA - Rechargeable battery

