





EN: Wall and ceiling lamp. Rotational-moulded polyethylene diffuser fixed to a varnished metal structure.

IT: Lampada da parete e da soffitto. Diffusore in polietilene stampato in rotazionale, fissato a struttura portante in metallo verniciato.

#### CERTIFICATIONS / CERTIFICAZIONI

 Product in class I  
Apparecchio di classe I

IP20 Product for indoor use  
Apparecchio per uso interno

 Product in conformity with the European directive 2006/95/EC  
Apparecchio conforme alla direttiva europea 2006/95/EC

 Product in conformity with the Eurasian Custom Unions technical regulations  
Apparecchio conforme ai regolamenti tecnici dell'Unione doganale Eurasiatica

 This lamp must be disposed in conformity with the EU directive 2002/96/EC  
Apparecchio di illuminazione da smaltire secondo la direttiva EU 2002/96/EC

#### CODES AND DIMENSIONS / CODICI E DIMENSIONI

044128BIEU

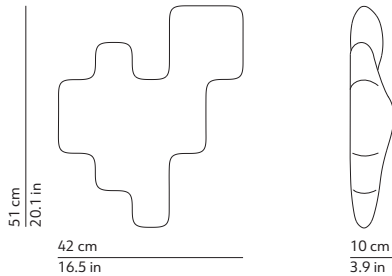

#### PACKAGING / IMBALLO

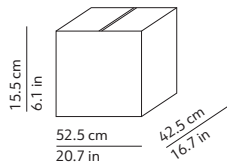

Volume: 0.035 m<sup>3</sup> / 1.221 ft<sup>3</sup>  
Gross weight: 2.10 kg / 4.62 lbs

#### MATERIALS AND FINISHINGS / MATERIALI E FINITURE

##### DIFFUSER / DIFFUSORE

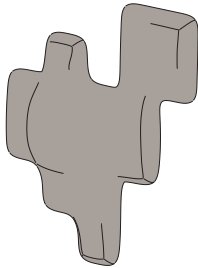

 White / Bianco

Roto-moulded polyethylene  
Polietilene stampato in rotazionale

##### STRUCTURE / STRUTTURA

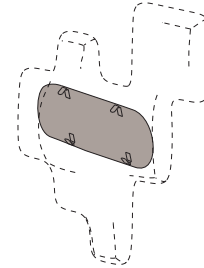

 White / Bianco

Varnished metal structure  
Struttura in metallo verniciato

#### FURTHER INFORMATION / INFORMAZIONI AGGIUNTIVE

 230V or 120V Feeding / Alimentazione

Light source / Sorgente luminosa  
3 x 12W max - E14 (E12)

 Energy efficiency class from A++ to E

 Dimmable / Dimmerabile  
Yes

 Wall and ceiling lamp  
Lampada da parete e soffitto

ASSEMBLY INSTRUCTIONS  
ISTRUZIONI DI MONTAGGIO  
INSTRUCCIONES DE MONTAGE  
MONTAGE-ANLEITUNG  
INSTRUCCIONES DE MONTAJE  
ИНСТРУКЦИИ ПО МОНТАЖУ

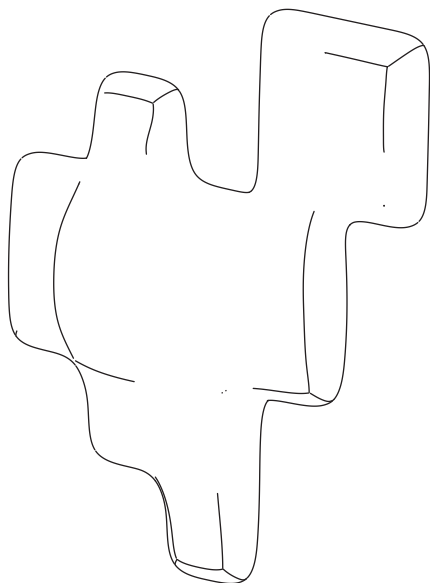

# PIXEL

BAKERY GROUP

## WARNING

The safety is guaranteed by the appropriate use of the following instructions, so you must keep them. Always disconnect the main voltage before working on the appliance. Never use abrasive products or aggressive detergents for cleaning the lamp. If the external cable of this appliance is damaged, it must be replaced by the manufacturer, its after sales service or other equivalent qualified person only in order to avoid any danger. Kundalini will not provide a replacement until the nature of defect has been determined.

## ATTENZIONE

La sicurezza dell'apparecchio è garantita con l'uso appropriato delle seguenti istruzioni, pertanto è necessario conservarle. Togliere sempre la tensione prima di operare sull'apparecchio. Per pulire la lampada non usare mai prodotti abrasivi o detergenti aggressivi. Se il cavo esterno di questo apparecchio viene danneggiato, deve essere sostituito esclusivamente dal costruttore, dal suo servizio assistenza, o da personale qualificato equivalente, al fine di evitare pericoli. Kundalini non effettuerà nessuna sostituzione se non dopo aver accertato la natura del difetto.

## ATTENTION

La sûreté de l'appareil n'est garantie qu'en suivant scrupuleusement les instructions ci-après. Il est donc nécessaire de les conserver. Isoler l'appareil du secteur avant toute manipulation. Pour nettoyer la lampe, ne jamais utiliser de produits abrasifs ou de nettoyeurs agressifs. Si le câble externe de cet appareil est endommagé, il doit être remplacé uniquement par les soins du constructeur, par son service après-vente ou bien par le personnel équivalent, et ce afin d'éviter tout danger. Kundalini ne remplacera aucun appareil sans en avoir pu vérifier le défaut.

## ACHTUNG

Die Sicherheit dieses Artikels wird nur durch die strikte Befolgung der nachfolgenden Betriebsanleitung gewährleistet. Bitte heben Sie diese unbedingt auf. Vor allen Arbeiten ziehen Sie bitte den Stecker aus der Dose. Für die Reinigung der Lampe niemals Schleifmittel oder aggressive Reinigungsmittel verwenden. Sollte das Außenkabel der Lampe beschädigt werden, ist es ausschließlich vom Service-Dienst des Herstellers oder gleichwertigen, qualifiziertem Personal auszutauschen, um somit Gefahren zu vermeiden. Kundalini leistet grundsätzlich erst nach einer gründlichen Überprüfung Ersatz.

## ATENCIÓN

La seguridad del aparato está garantizada sólo con el uso apropiado de las instrucciones siguientes, por lo tanto es necesario atenderlas puntualmente. Desconectar siempre la alimentación antes de trabajar en el aparato. Nunca utilice productos abrasivos o detergentes agresivos para limpiar la lámpara. Si el cable externo de este aparato se deteriora será necesario sustituirlo; la sustitución podrá efectuarla exclusivamente el fabricante, su servicio de asistencia o personal cualificado equivalente para evitar peligros. Kundalini no efectuará sustitución alguna hasta después de haber verificado la naturaleza del defecto.

## ВНИМАНИЕ!

Безопасность прибора обеспечивается за счет правильного пользования настоящими инструкциями, поэтому необходимо их сохранять. Перед началом работы на приборе всегда отключать напряжение. Для очистки лампы не использовать абразивные продукты или агрессивные чистящие средства. Если внешний кабель прибора поврежден, во избежание опасностей он должен быть заменен только изготовителем, его сервисной службой или равнозначным квалифицированным персоналом. Kundalini не выполняет никаких замен, если не было установлено происхождение дефекта.



IP20



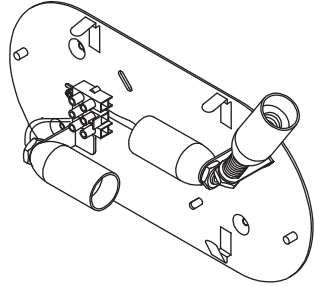
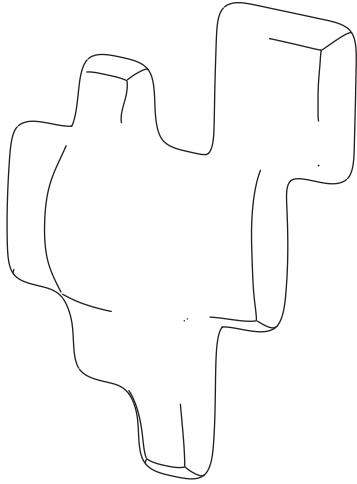

**BOX N.1**

.1

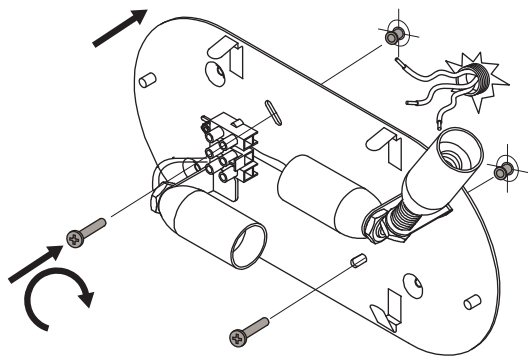

.2

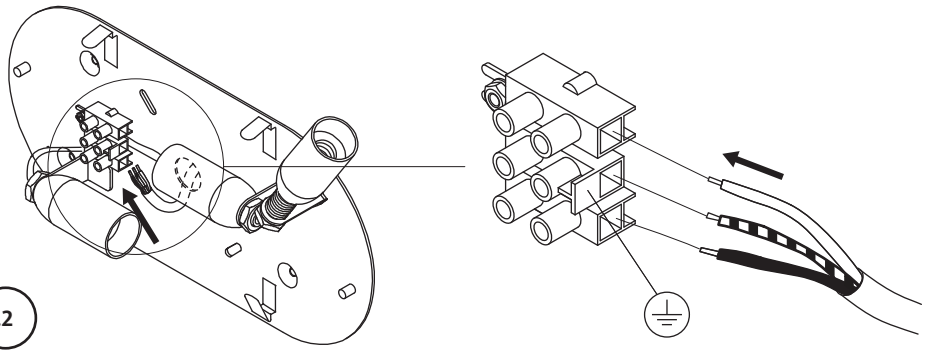

.3

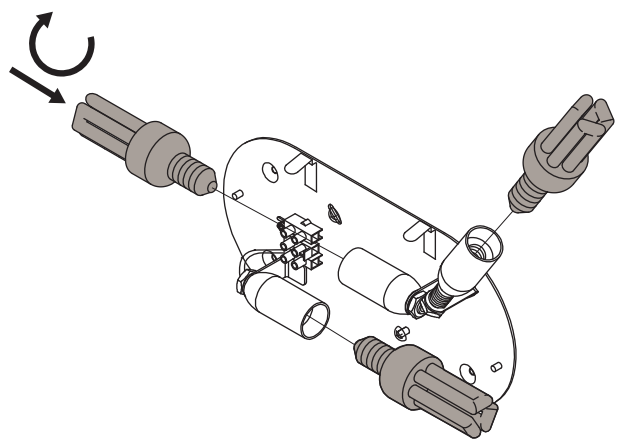

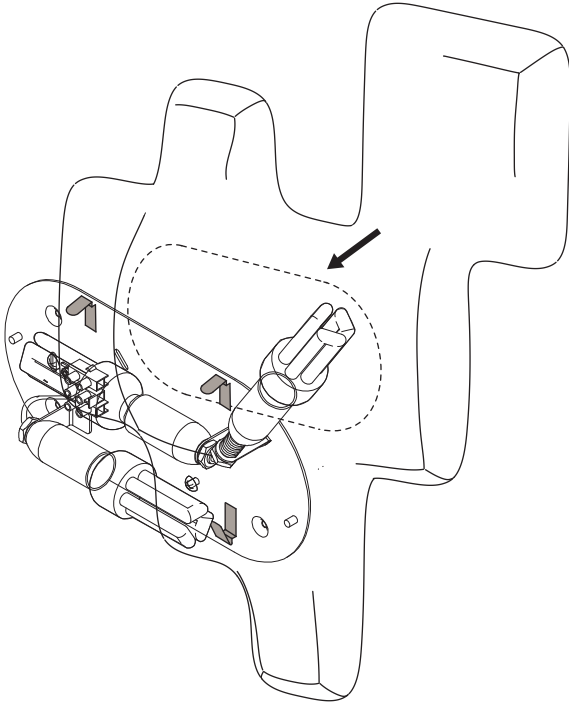

.4

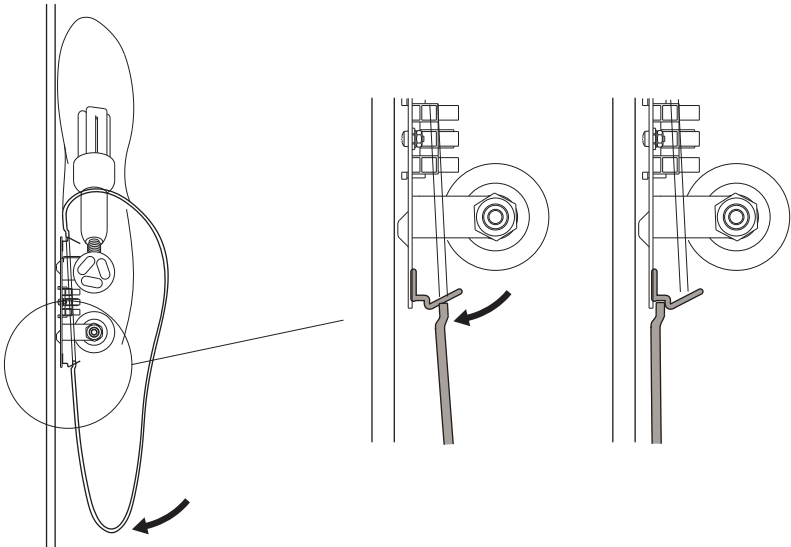

.5

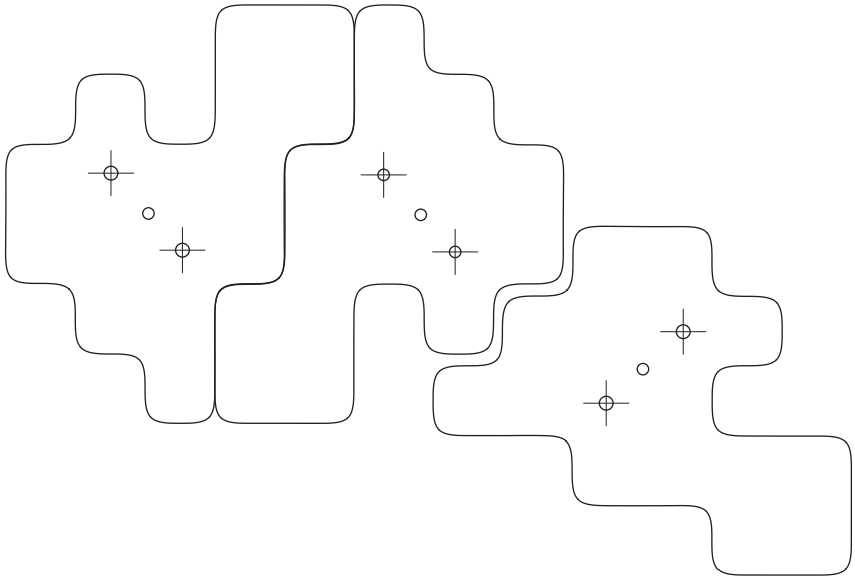

**.6** Multiple compositions

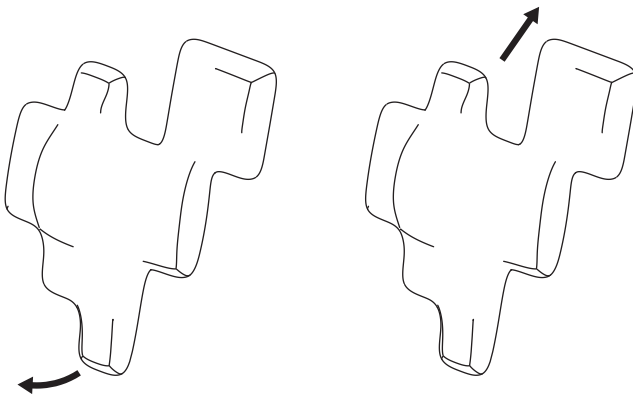

**.7** Bulbs replacement

**BULBS, LAMPADINE, AMPOULES, LEUCHTENMITTEL, BOMBILLAS, ТИП ЛАМПОЧКИ**

3 x 12W - E14 (E12 US)

Energy efficiency class from A++ to E

**FEEDING, ALIMENTAZIONE, ALIMENTATION, SPANNUNG, TENSION DE RED, НАПРЯЖЕНИЕ**

220-240 / 120 V



